

40W FDS-DALI-2 Dimming power supply

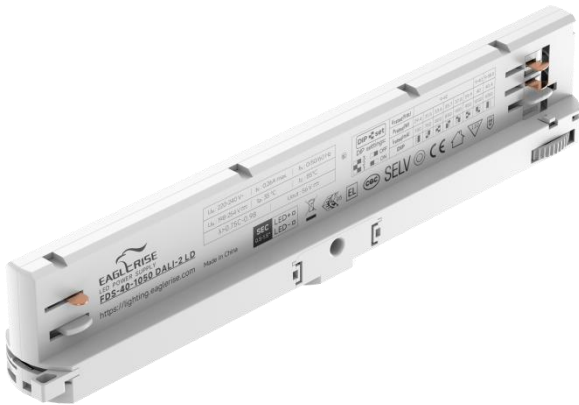

■ Approve



◆ Description

FDS-40-1050 DALI-2 LD is a 40W constant current LED driver that operates from 198-264Vac input with 700mA to 1050mA output current and a forward voltage range from 9 to 42Vdc. The output current is adjustable by DIP Switch. With it's compact dimensions from 248 x 31 x 45 mm. It is easy to integrate in track light products. To ensure trouble-free operation, protection is provided against output short circuit and over Load.

◆ Model code

FDS-40-1050 DALI-2 LD

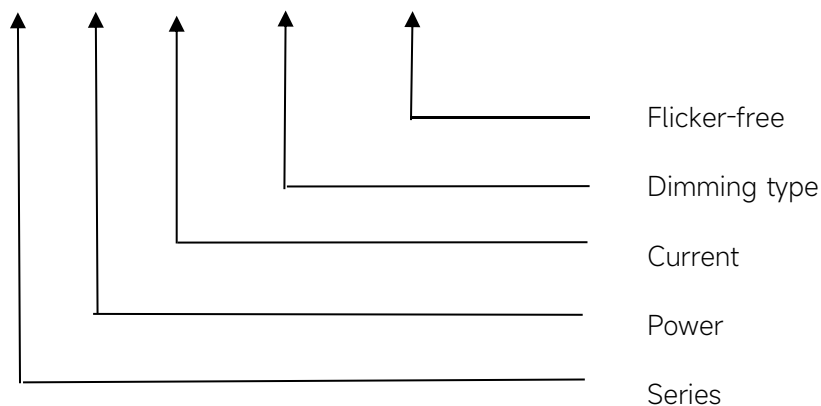

Features

- Class II,SELV,Built-in
- Input Voltage 220-240VAC
- Protections: SCP/OLP/OVP/OTP
- Power Factor 0.75C-0.98
- Efficiency $\geq 86\%$
- Adjustable Output Current with dip-switch
- Support DALI-2
- 5 years warranty

Applications

- Track light

◆ Specification

	Constant Current (mA)	700	750	800	850	900	950	1000	1050	
Output	Voltage Range (VDC)	9-42						9-40	9-38.5	
	Unload voltage Max.	56VDC								
	Current Accuracy	±5%								
	Output HF current ripple(≥1KHz)	±10%								
	Output LF current ripple(≤120Hz)	±3%								
	SVM	≤0.4								
	P _{st}	≤1								
	Efficiency(Typ.)	≥86%@Full load,230V								
	Input	Rated input voltage	220-240VAC							
Range of input voltage		198-264VAC								
Range input voltage(DC)		198-280VDC								
Frequency(Hz)		0/50/60 Hz								
Displacement factor		≥0.9								
Power Factor		0.75C-0.98								
Input Current		0.26A								
Start-up time		< 0.5S								
No Load Power		≤0.5W								
Standby Power		≤0.5W								
Network standby power		≤0.5W								
THD (Typ.)		<10%								
Dimming	Dimming	YES								
	Dimming mode	DALI-2 (IEC 62386-101,102,207)								
	Dimming depth	1%								
	Dimming current range	1 ~100%								
Protection	Over Load Protection	103-120%								
		YES/Latch off								
	Over Voltage Protection	> 56VDC								
		YES/Latch off								
	Short circuit Protection	YES/Latch off								
	Over Temperature Protection	YES/Auto Resume								
Environment	Operating Temperature	-20°C~-+35°C								
	Humidity	20%-90%RH								
	Tc	85°C								
	Storage Temperature	-20°C~-+60°C								
	Lifetime	>50000h,@Tc=85°C								
Surface	Dimension	248X31X45(LXWXH)mm								

Standards	EEN 61347-1,EN 61347-2-13(CE-LVD,ENEC) IEC 61347-1,IEC 61347-2-13(CB) EN 62384(ENEC) EN IEC 55015,EN IEC 61000-3-2,EN 61000-3-3(CE-EMC) EN 61547(CE-EMC)	
Others	ErP	EU 2019/2020
	RoHS	RoHS (2011/65/EU) (EU)2015/863
Note	<p>1.All parameters NOT specially mentioned are measured at 230VAC input , full load and 25°C of ambient temperature.</p> <p>2.Ripple & Noise are measured at 20MHz of bandwidth by using a 300mm twisted pair-wire terminated with a 0.1uF & 47 uF parallel capacitor.</p> <p>3.Switch and dimmer are not recommended to connect between this product output and luminaries.</p> <p>4.The DC input for this product is only used for emergency lighting and applies to functional and safety requirements, EMC is not considered.</p>	

◆ Parameter

Number	Output	Switch position		
	Current(mA)	1	2	3
1	700	--	--	--
2	750	ON	--	--
3	800	--	ON	--
4	850	ON	ON	--
5	900	--	--	ON
6	950	ON	--	ON
7	1000	--	ON	ON
*8	1050	ON	ON	ON

* Factory default

◆ Circuit Breaker

I _{peak}	T _{width}	B10	B16	B20	C10	C16	C20
14.7A	101.6μs	30pcs	49pcs	61pcs	30pcs	49pcs	61pcs

◆ **Wiring diagram**

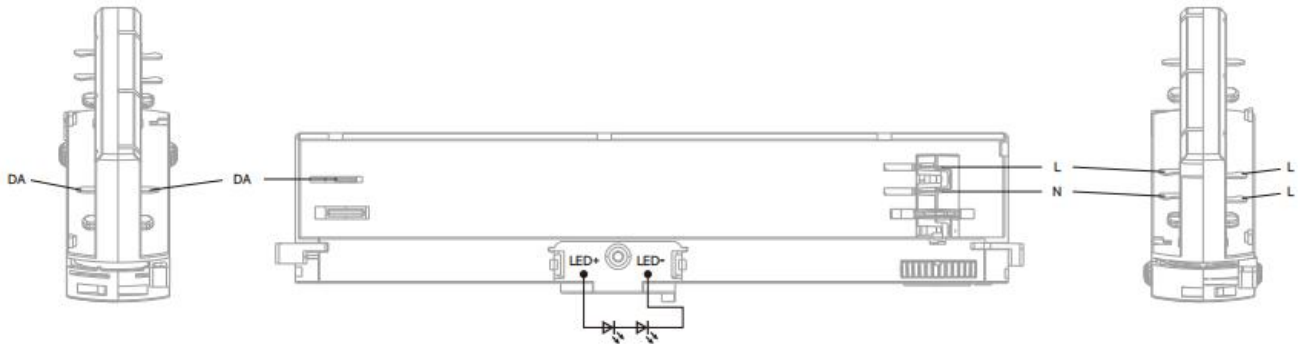

◆ **2D diagram**

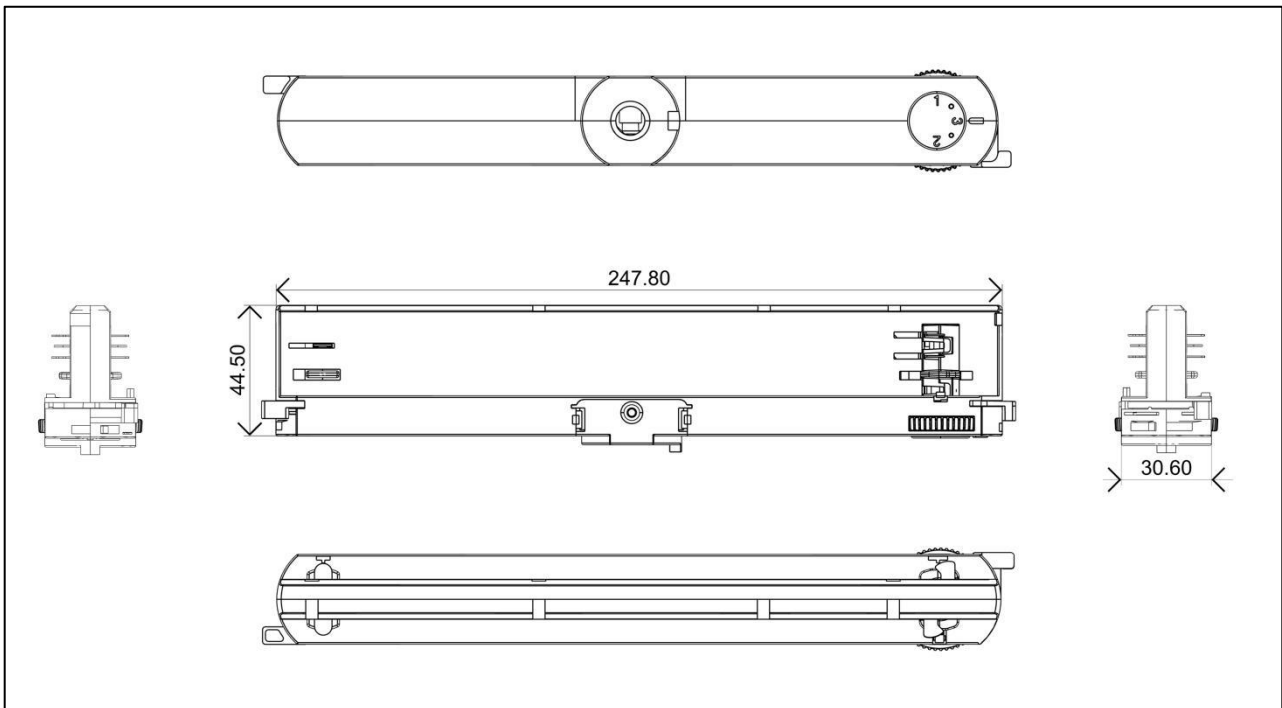

◆ **Wiring & Connections**

Specification item		Value (Unit)
Output	Output wire cross-section	0.5...1.5 mm ²
	Output wire gauge.	16...20 AWG
	Output wire strip length	8...9mm

◆ Matching brand

Manufacturer	Type	System	Intrack casing colour
POWERGEAR	PRO-0610	3P+DALI	Black, white, gray
Global	XTSC 6xxx	3P+DALI	Black, white, gray
Unipro	TC33B	3P+DALI	Black, white, gray
Stucchi	9000-2/ B-ST	3P+DALI	Black, white, gray

◆ **Curve for FDS-40-1050 DALI-2 LD, I_o=1050mA**

Lifetime vs. Temperature Curve

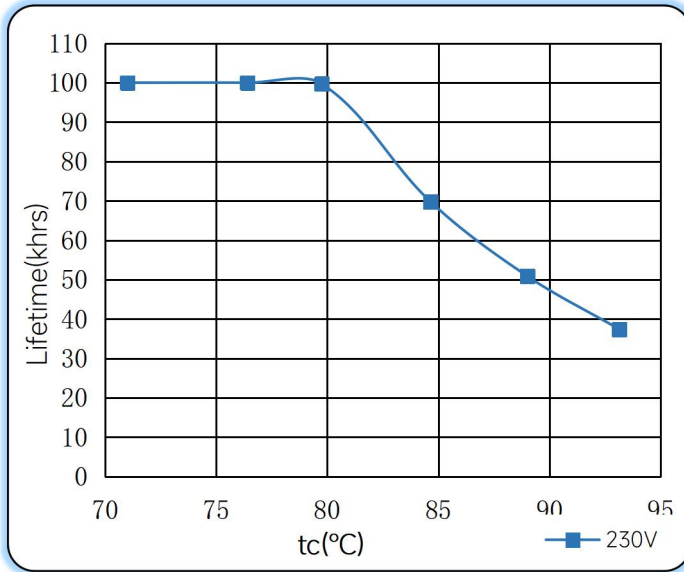

Efficiency vs. Load

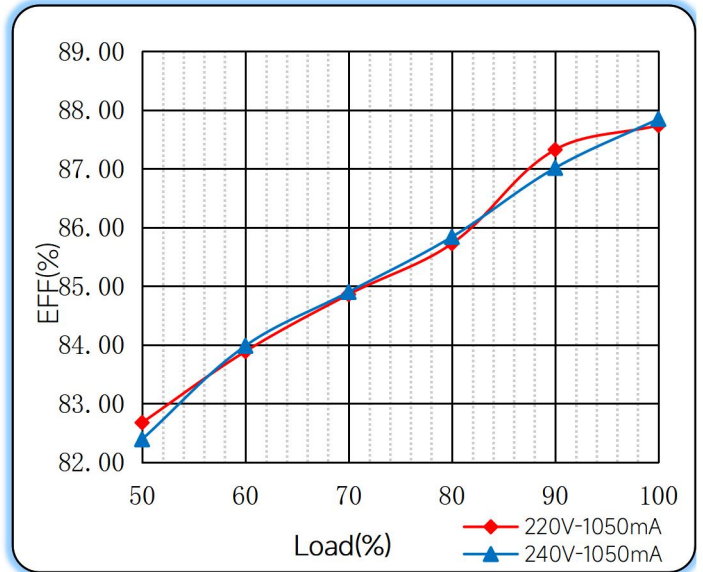

Power Factor Characteristics

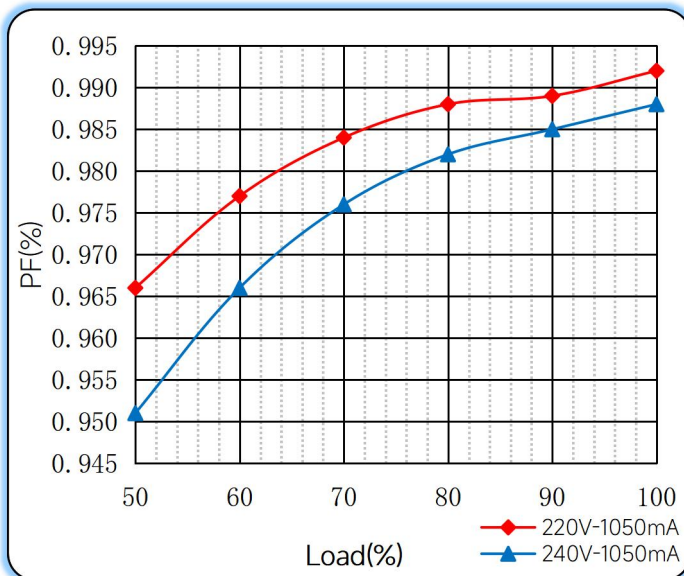

THD vs. Load

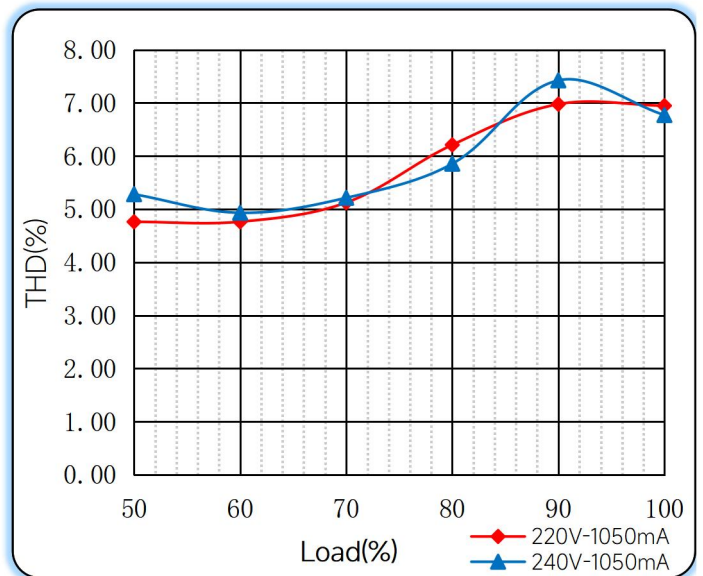

◆ **Operating window**

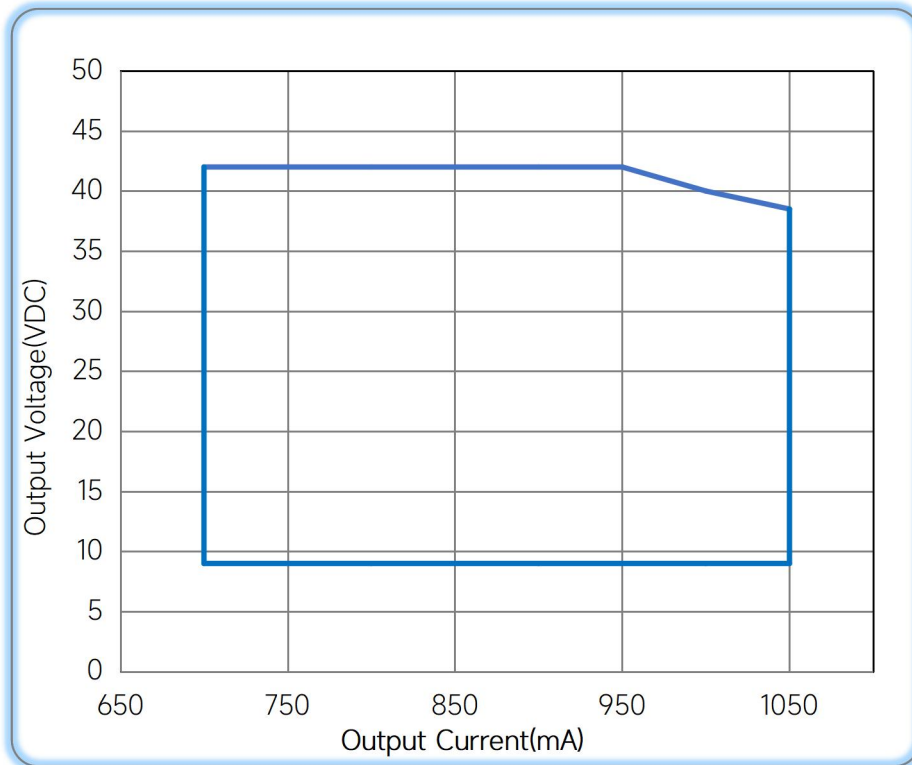

◆ **Revision Updates**

ITEM	BEFORE	AFTER	VERSION	DATE
Initial			A	2022/10/24
Updated			B	2023/03/09

Tel: +86-0757-86256822, +86-0757-86256831

E-mail: sales@eaglerise.com

Website : <https://lighting.eaglerise.com>



EAGLERISE



Manual