

## 30W FDS-DALI-2 Dimming power supply

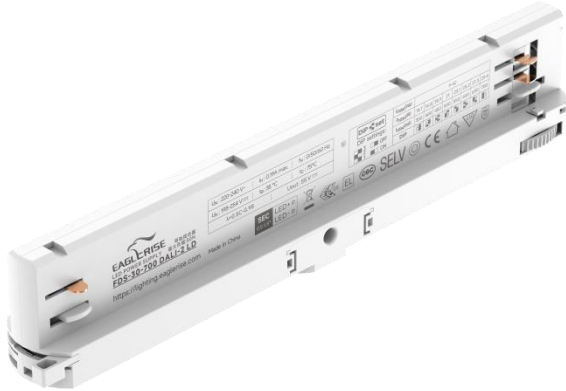

■ Approve



### Features

- Class II,SELV,Built-in
- Input Voltage 220-240VAC
- Protections: SCP/OLP/OVP/OTP
- Power Factor: 0.5C-0.98
- Efficiency:  $\geq 85\%$
- Adjustable Output Current with dip-switch
- Support DALI-2
- 5 years warranty

### Applications

- Track light

### ◆ Description

FDS-30-700 DALI-2 LD is a 30W constant current LED driver that operates from 198-264Vac input with 350mA to 700 mA output current and a forward voltage range from 9 to 42Vdc. The output current is adjustable by DIP Switch. With it's compact dimensions from 248 x 31 x 45 mm. It is easy to integrate in track light products. To ensure trouble-free operation, protection is provided against output short circuit and over Load.

### ◆ Model code

#### FDS-30-700 DALI-2 LD

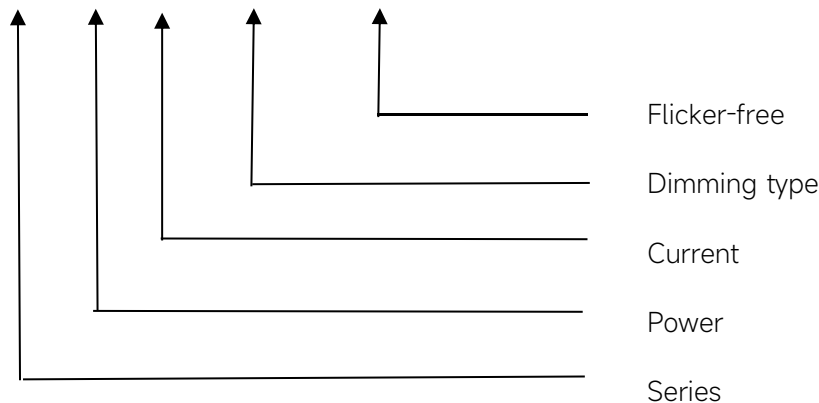

## ◆ Specification

	Constant Current (mA)	350	400	450	500	550	600	650	700
Output	Voltage Range (VDC)	9-42VDC							
	Unload voltage Max.	55VDC							
	Current Accuracy	±5%							
	Output HF current ripple(≥1KHz)	±10%							
	Output LF current ripple(≤120Hz)	±3%							
	SVM	≤0.4							
	P <sub>st</sub>	≤1							
	Efficiency(Typ.)	≥85%@Full load,230V							
	Input	Rated input voltage	220-240VAC						
Range of input voltage		198-264VAC							
Range input voltage(DC)		198-280VDC							
Frequency(Hz)		0/50/60 Hz							
Displacement factor		≥0.9							
Power Factor		0.5C-0.98							
Input Current		0.19A							
Start-up time		< 0.5S							
No Load Power		≤0.5W							
Standby Power		≤0.5W							
Network standby power		≤0.5W							
THD (Typ.)		<10%@Full load,230V							
Dimming	Dimming	YES							
	Dimming mode	DALI-2 (IEC 62386-101,102,207)							
	Dimming depth	1%							
	Dimming current range	1 ~100%							
Protection	Over Load Protection	103-120%							
		YES/Latch off							
	Over Voltage Protection	> 55VDC							
		YES/Latch off							
	Short circuit Protection	YES/Latch off							
	Over Temperature Protection	YES/Auto Resume							
Environment	Operating Temperature	-20°C~-+35°C							
	Humidity	20%-90%RH							
	Tc	75°C							
	Storage Temperature	-20°C~-+60°C							
	Lifetime	>50000h,@Tc=75°C							
Surface	Dimension	248X31X45(LXWXH)mm							

Standards	EN 61347-1,EN 61347-2-13(CE-LVD,ENEC) IEC 61347-1,IEC 61347-2-13(CB) EN 62384(ENEC) EN IEC 55015,EN IEC 61000-3-2,EN 61000-3-3(CE-EMC,) EN 61547(CE-EMC)	
Others	ErP	EU 2019/2020
	RoHS	RoHS (2011/65/EU) (EU)2015/863
Note	<p>1.All parameters NOT specially mentioned are measured at 230VAC input , full load and 25°C of ambient temperature.</p> <p>2.Ripple &amp; Noise are measured at 20MHz of bandwidth by using a 300mm twisted pair-wire terminated with a 0.1uF &amp; 47 uF parallel capacitor.</p> <p>3.Switch and dimmer are not recommended to connect between this product output and luminaries.</p> <p>4.The DC input for this product is only used for emergency lighting and applies to functional and safety requirements, EMC is not considered.</p>	

## ◆ Parameter

Number	Current(mA)	Switch position		
		1	2	3
1	350mA	--	--	--
2	400mA	ON	--	--
3	450mA	--	ON	--
4	500mA	ON	ON	--
5	550mA	--	--	ON
6	600mA	ON	--	ON
7	650mA	--	ON	ON
*8	700mA	ON	ON	ON

\* Factory default

## ◆ Circuit Breaker

I <sup>peak</sup>	T <sup>width</sup>	B10	B16	B20	C10	C16	C20
17.6A	101.1μs	30pcs	49pcs	61pcs	30pcs	49pcs	61pcs

◆ **Wiring diagram**

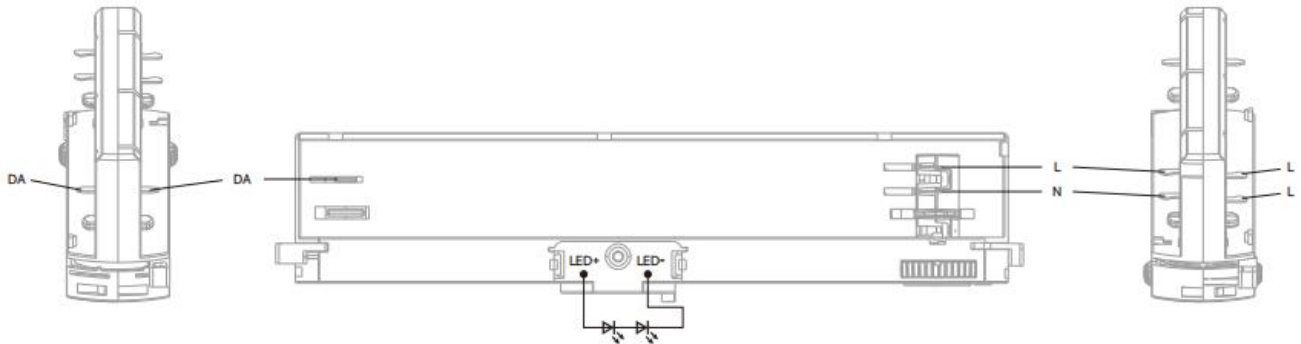

◆ **2D diagram**

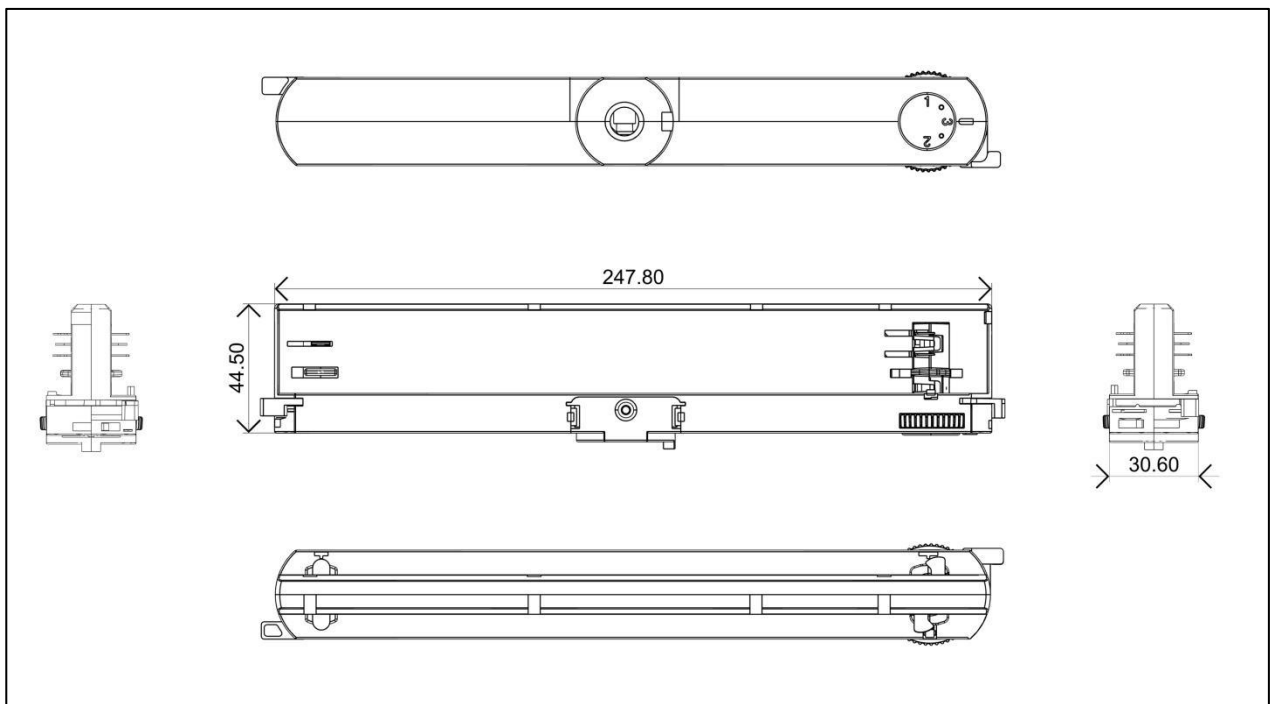

◆ **Wiring & Connections**

Specification item		Value (Unit )
Output	Output wire cross-section	0.5...1.5 mm <sup>2</sup>
	Output wire gauge.	16...20 AWG
	Output wire strip length	8...9mm

**◆ Matching brand**

Manufacturer	Type	System	Intrack casing colour
POWERGEAR	PRO-0610	3P+DALI	Black, white, gray
Global	XTSC 6xxx	3P+DALI	Black, white, gray
Unipro	TC33B	3P+DALI	Black, white, gray
Stucchi	9000-2/ B-ST	3P+DALI	Black, white, gray

◆ **Curve for FDS-30-700 DALI-2 LD, I<sub>o</sub>=700mA**

Lifetime vs. Temperature Curve

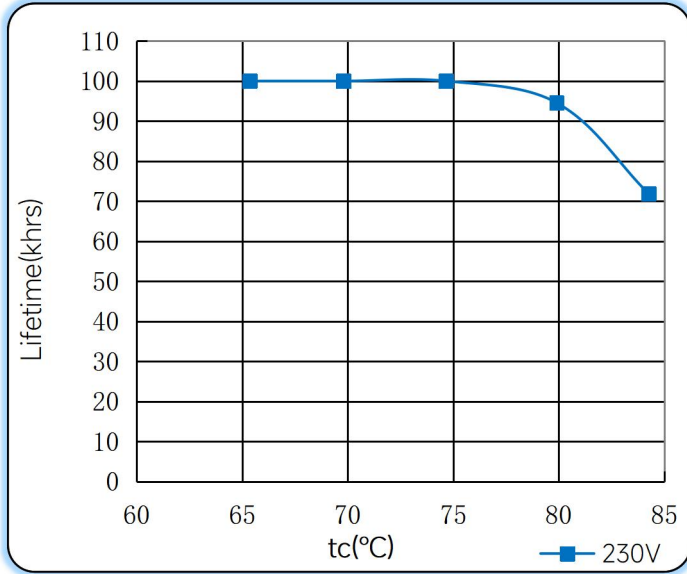

Efficiency vs. Load

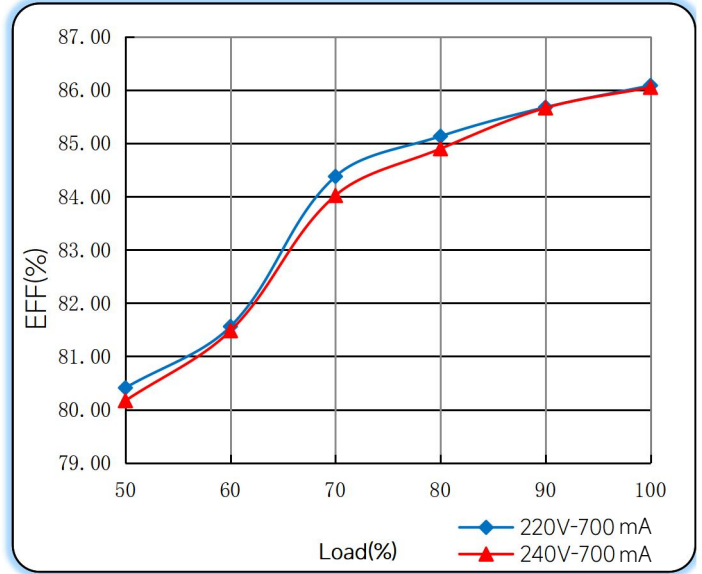

Power Factor Characteristics

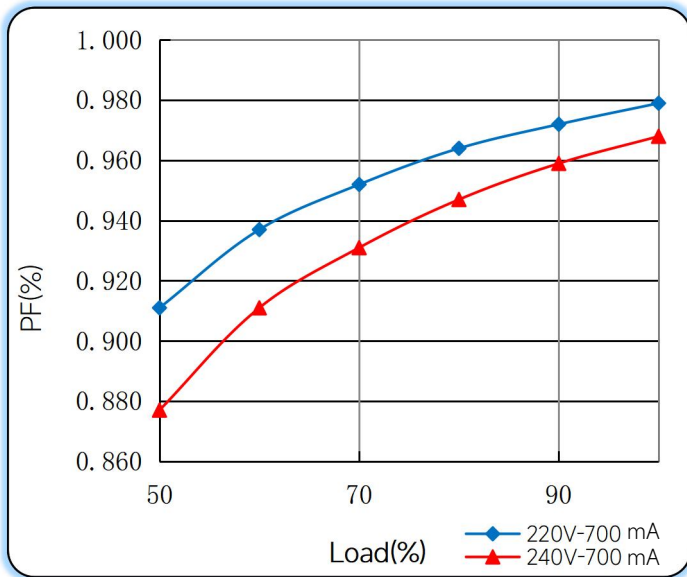

THD vs. Load

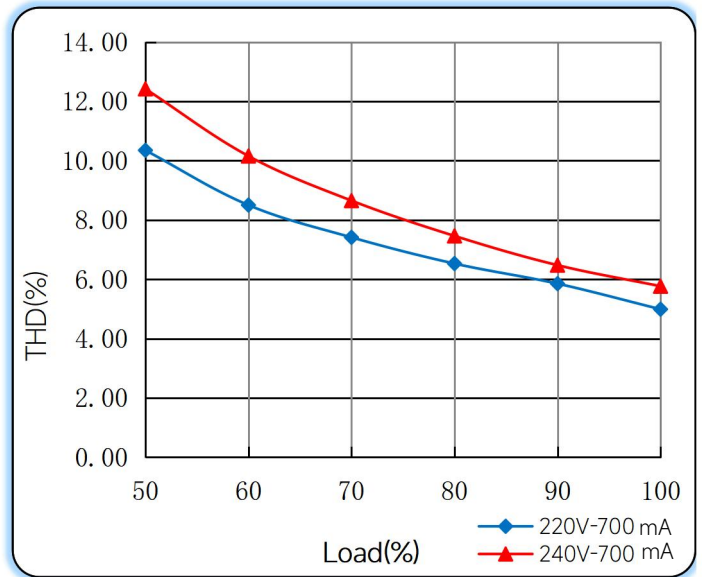

### ◆ Operating window

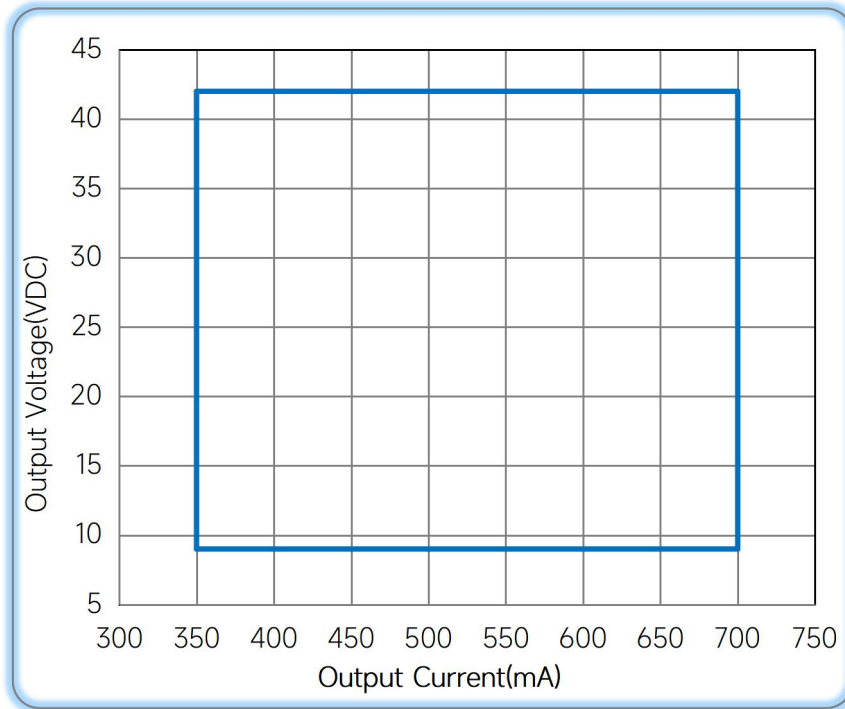

— Operating window 100%

### ◆ Revision Updates

ITEM	BEFORE	AFTER	VERSION	DATE
Initial			A	2022/10/24
Updated			B	2023/03/09

Tel: +86-0757-86256822, +86-0757-86256831

E-mail: sales@eaglerise.com

Website : <https://lighting.eaglerise.com>



EAGLERISE



Manual