

## 80W Constant Current – DIP-Switch



■ Approve



### Features

- For luminaires of protection Class I or II, SELV, built-in
- Input Voltage : 220-240VAC
- Protections: SCP/OLP/OVP/OTP
- Power Factor : > 0.95
- Efficiency : ≥91%
- 5 years warranty

### Applications

- Linear light

### ◆ Description

FMS-80-2000 LD1 EXC is a 80W constant current LED driver that operates from 198-264Vac input with 1500 to 2000mA output current. The output current is selectable by DIP Switch. With it's dimensions from 280 x 30 x 21mm. It is easy to integrate in linear light products. To ensure trouble-free operation, protection is provided against output short circuit, over Load and over temperature.

### ◆ Model code

#### FMS-80-2000 LD1 EXC

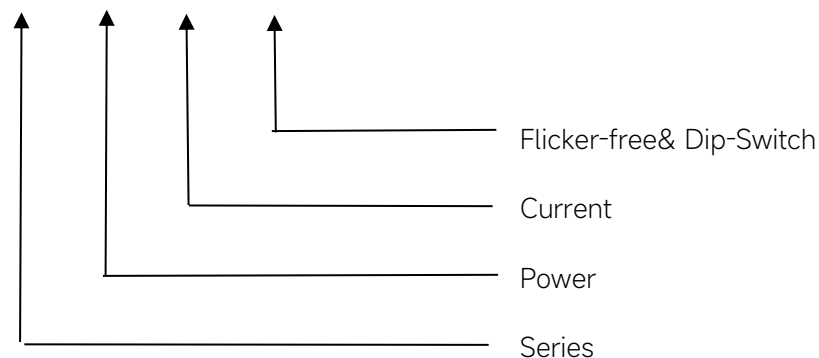

## ◆ Specification

Output	Constant Current	1500mA	1600mA	1700mA	1800mA	1900mA	2000mA	
	Voltage Range	24-42					24-40	
	Unload voltage Max.	59VDC						
	Current Accuracy	±5%						
	Output HF current ripple(≥1KHz)	±3%						
	Output LF current ripple(≤120Hz)	±3%						
	SVM	≤0.4						
	Pst	≤1						
	Efficiency(Typ.)	91%						
Input	Rated input voltage	220-240V						
	Range of input voltage	198-264VAC						
	Maximum voltage	300VAC@1 h maximum,unit might not operate in this abnormal condition						
	Range of input voltage(VDC)	176-280VDC						
	Frequency(Hz)	0/50/60 Hz						
	Power Factor	> 0.95						
	Input Current max	0.52A						
	Start-up time	< 0.5S						
	No Load Power	≤0.5W						
	THD (Typ.)	< 10%.						
Protection	Over Load Protection	103-130%						
		YES/Auto Resume						
	Over Voltage Protection	> 59VDC						
		YES/Auto Resume						
Short circuit Protection		YES/Auto Resume						
capability	Surge capability (L-N)	2KV						
	Surge capability (L/N-Ground)	2KV						
Environment	Operating Temperature	-20°C~+50°C						
	Humidity	20%-90%RH						
	Tc	85°C						
	Storage Temperature	-25°C~+80°C						
	Life time	> 50000h@Tc=75°C,230VAC						
	Noise	≤25dB(A)@20cm						
Surface	Dimension	280X30X21(LXWXH)mm						
	material	metal case						
Standards	Safety	GB19510. 1, GB19510. 14; EN61347- 1, EN61347-2- 13						
	EMC	GB/T17743, GB17625. 1; EN55015, EN61000-3-2, EN61000-3-3, EN61547						
	ErP	Erp2.0 EU 2019/2020						

	RoHS	RoHS (2011/65/EU) (EU)2015/863
Note	<p>1.All parameters NOT specially mentioned are measured at 230VAC input , full load and 25°C of ambient temperature.</p> <p>2.Ripple &amp; Noise are measured at 20MHz of bandwidth by using a 300mm twisted pair-wire terminated with a 0.1uF &amp; 47 uF parallel capacitor.</p> <p>3.The DC input for this product is only used for emergency lighting and applies to functional and safety requirements, EMC is not considered..</p> <p>4.EL compatible with IEC 61347-2-13 Annex J, compatible with EN 60598-2-22 emergency lighting fixtures, compatible with EN 50172 central battery system applications.</p> <p>5.The over-temperature protection of the product is provided by the IC.</p> <p>6.All Eaglerise power supply are complied with EMI regulations. Since they are belong to component and will be installed inside system enclosure. When they are integrated into a system, the EMI characteristics of the system must be re-verified again.</p>	

## ◆ Inrush Current

I <sub>peak</sub>	T <sub>width</sub>	B10	B16	B20	C10	C16	C20
46A	246μs	7pcs	11pcs	14pcs	11pcs	19pcs	23pcs

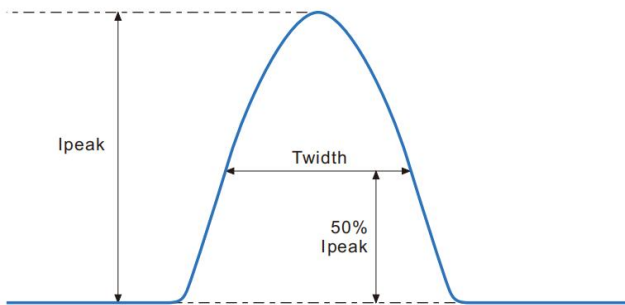

**Remarks:**

- 1.The number of drives mounted under different MCBs in the table is the maximum value. Please do not exceed this number during installation.
- 2.Different brands and models of miniature circuit breakers, the number of drives mounted will be slightly different.

◆ **Parameter**

Number	Output				Switch position		
	Current (mA)	Voltage (VDC)	Voltage No load (VDC)	Power (W)	1	2	3
1	1500mA	24-42VDC		63	--	--	--
2	1600mA			67.2	ON	--	--
3	1700mA			71.4	--	ON	--
4	1800mA			75.6	ON	ON	--
5	1900mA			79.8	--	ON	ON
*6	2000mA	24-40VDC		80	ON	ON	ON

\* Factory default

◆ **Wiring diagram**

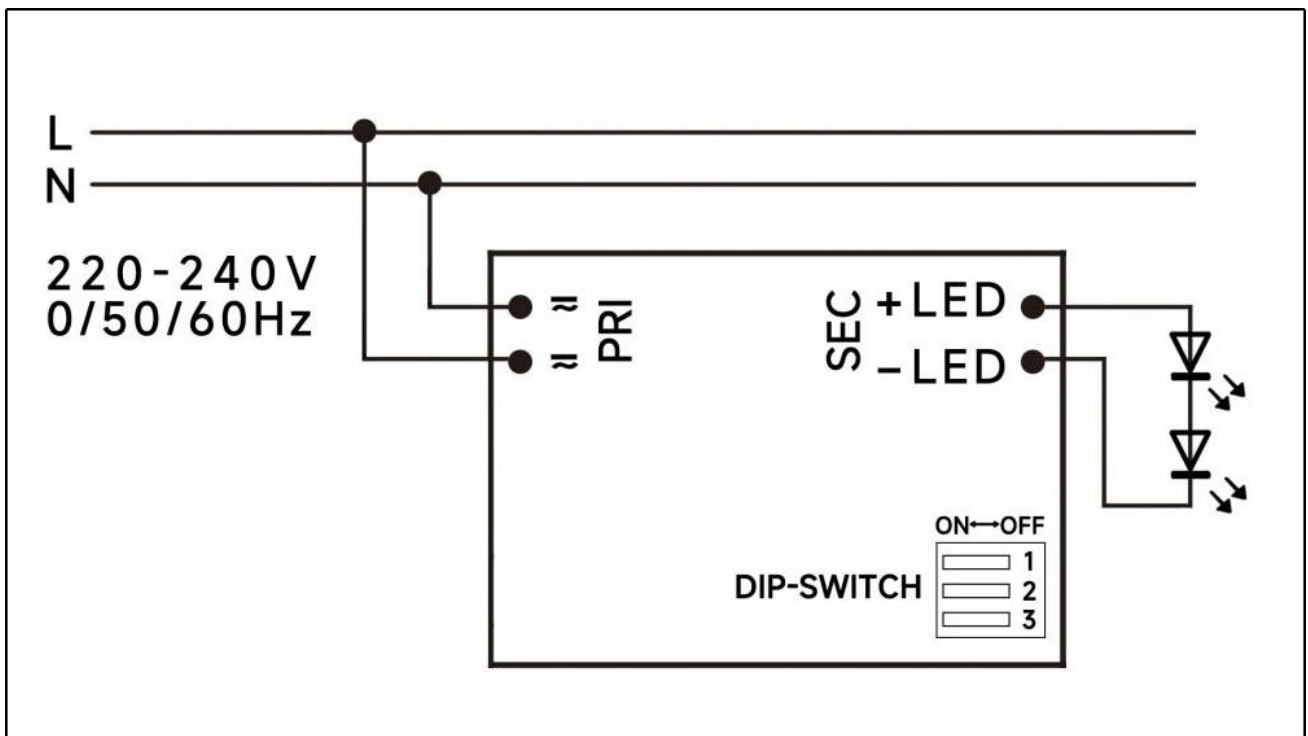

### ◆ 2D diagram

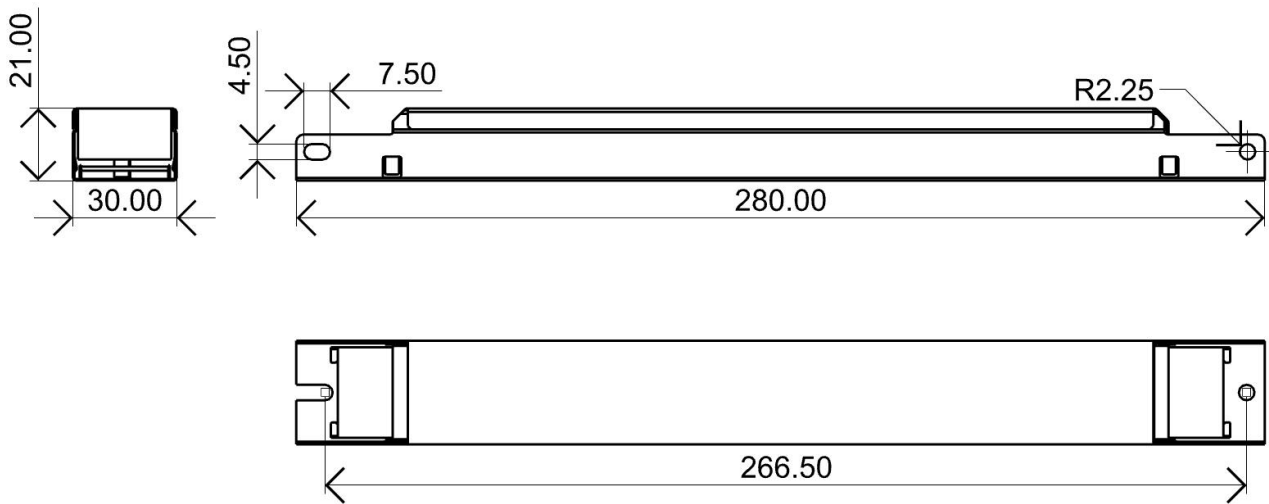

### ◆ Wiring & Connections

Specification item		Value (Unit )
Input	Input wire cross-section	0.5...1.5 mm <sup>2</sup> (With side caps: 0.75...1.5 mm <sup>2</sup> )
	Input wire gauge.	16...20 AWG (With side caps: 16...22 AWG )
	Input wire strip length	7...9mm
Output	Output wire cross-section	0.5...1.5 mm <sup>2</sup>
	Output wire gauge.	16...20 AWG
	Output wire strip length	7...9mm

Note: Solid wire is risky to use on an angled terminal. Stranded wire is recommended for this kind of use.

### ◆ Curve for FMS-80-2000 LD1 EXC, I<sub>o</sub>=2000mA

Lifetime vs. Temperature Curve

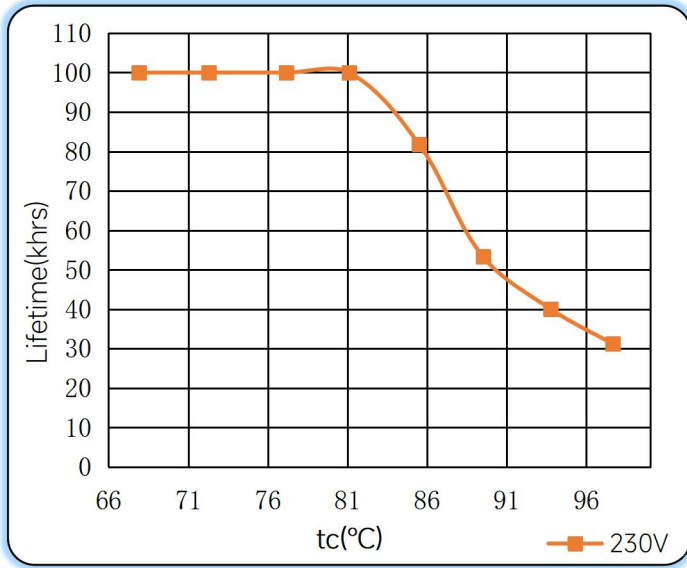

Efficiency vs. Load

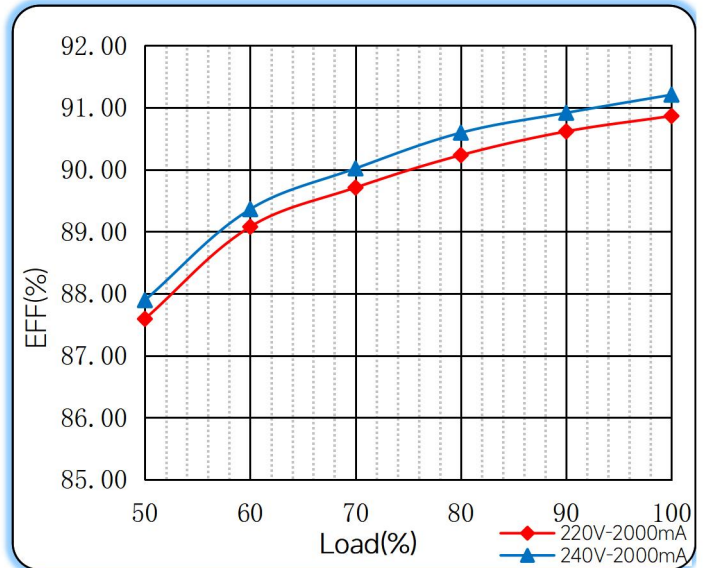

Power Factor Characteristics

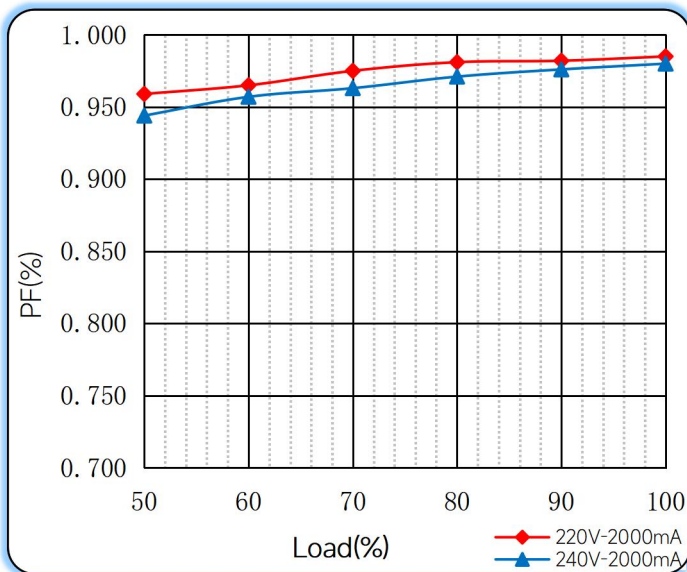

THD vs. Load

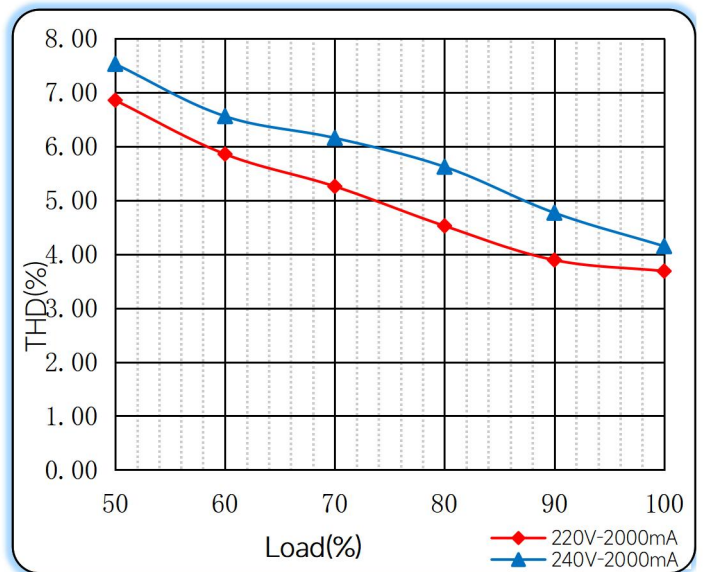

◆ **Operating window**

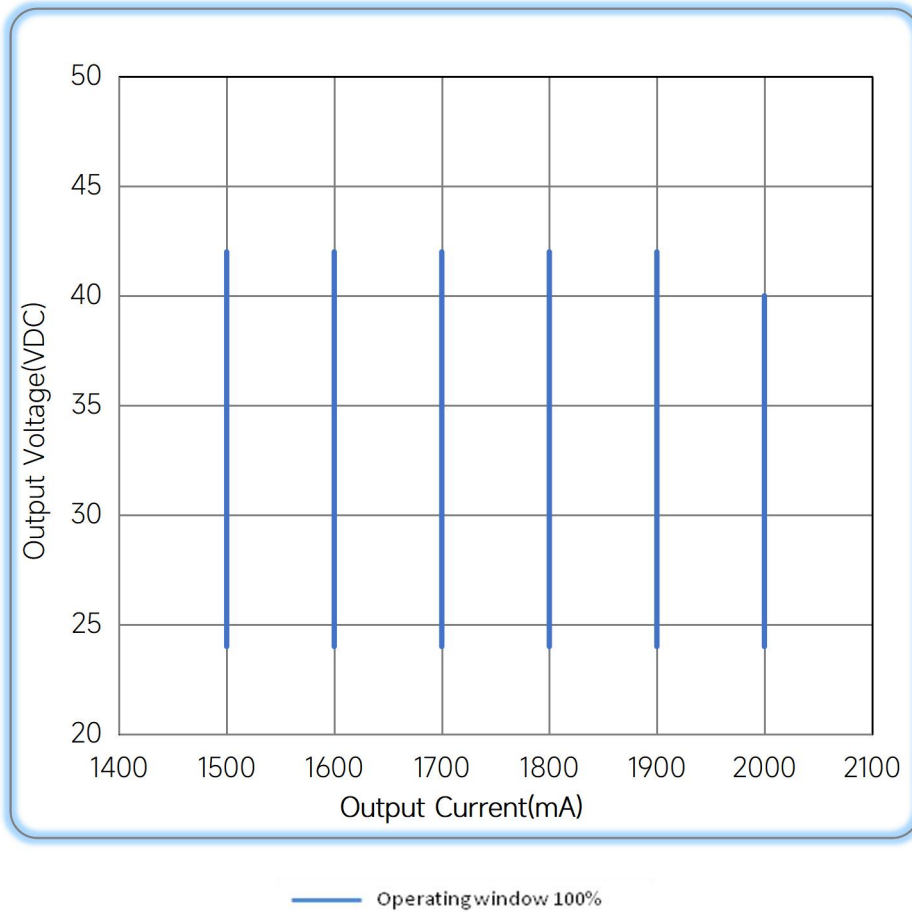

◆ **Revision Updates**

ITEM	BEFORE	AFTER	VERSION	DATE
Initial			A	2024/08/15

Remark: The final interpretation of the contents of the specification belongs to Eaglerise Electric & Electronic (China) Co., Ltd.

Tel: +86-0757-86256822, +86-0757-86256831

E-mail: sales@eaglerise.com

Website : <https://lighting.eaglerise.com>



EAGLERISE



Manual