

75W Constant Current – DIP-Switch



Features

- For luminaires of protection Class I or II, SELV, built-in
- Input Voltage : 220-240VAC
- Protections: SCP/OLP/OVP/OTP
- Power Factor : > 0.95
- Efficiency : ≥91%
- 5 years warranty

Applications

- Linear light

■ Approve

CE CB SELV



◆ Description

FMS-75-1500 LD EXC is a 75W constant current LED driver that operates from 198-264Vac input with 1150 to 1500mA output current. The output current is selectable by DIP Switch. With its dimensions from 280 x 30 x 21mm. It is easy to integrate in linear light products. To ensure trouble-free operation, protection is provided against output short circuit, over Load and over temperature.

◆ Model code

FMS-75-1500 LD EXC

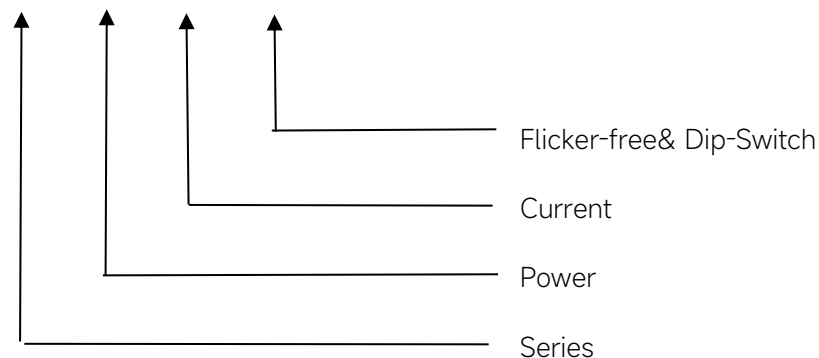

◆ Specification

Output	Constant Current	1150mA	1200mA	1250mA	...	1450mA	1500mA
	Voltage Range	15-51VDC				15-51VDC	15-50VDC
	Unload voltage Max.	59VDC					
	Current Accuracy	±5%					
	Output HF current ripple(≥1KHz)	±3%					
	Output LF current ripple(≤120Hz)	±3%					
	SVM	≤0.4					
	Pst	≤1					
	Efficiency(Typ.)	91%					
Input	Rated input voltage	220-240V					
	Range of input voltage	198-264VAC					
	Maximum voltage	300VAC@1 h maximum,unit might not operate in this abnormal condition					
	Range of input voltage(VDC)	176-280VDC					
	Frequency(Hz)	0/50/60 Hz					
	Power Factor	≥0.95					
	Input Current max	0.5A					
	Start-up time	< 0.5S					
	No Load Power	≤0.5W					
	THD (Typ.)	< 10%.					
Protection	Over Load Protection	103-120%					
		YES/Auto Resume					
	Over Voltage Protection	> 59VDC					
		YES/Auto Resume					
Short circuit Protection		YES/Auto Resume					
capability	Surge capability (L-N)	2KV					
	Surge capability (L/N-Ground)	2KV					
Environment	Operating Temperature	-20°C~+60°C					
	Humidity	20%-90%RH					
	Tc	90°C					
	Storage Temperature	-25°C~+80°C					
	Life time	> 50000h@Tc=85°C,230VAC					
	Ripple&Noise	≤25dB(A)@20cm					
Surface	Dimension	280X30X21(LXWXH)mm					
	material	metal case					
Standards	Safety	GB19510. 1, GB19510. 14; IEC61347- 1, IEC61347-2- 13; EN61347- 1, EN61347-2-					
	EMC	GB/T17743, GB17625. 1; EN55015, EN61000-3-2, EN61000-3-3, EN61547;					
	ErP	Erp2.0 EU 2019/2020					
	RoHS	RoHS (2011/65/EU) (EU)2015/863					

Note	<p>1.All parameters NOT specially mentioned are measured at 230VAC input , full load and 25°C of ambient temperature.</p> <p>2.Ripple & Noise are measured at 20MHz of bandwidth by using a 300mm twisted pair-wire terminated with a 0.1uF & 47 uF parallel capacitor.</p> <p>3.The DC input for this product is only used for emergency lighting and applies to functional and safety requirements, EMC is not considered..</p> <p>4.EL compatible with IEC 61347-2-13 Annex J, compatible with EN 60598-2-22 emergency lighting fixtures, compatible with EN 50172 central battery system applications.</p> <p>5.The over-temperature protection of the product is provided by the IC.</p> <p>6.All Eaglerise power supply are complied with EMI regulations. Since they are belong to component and will be installed inside system enclosure. When they are integrated into a system, the EMI characteristics of the system must be re-verified again.</p>
------	---

◆ Inrush Current

I_{peak}	Twidth	B10	B16	B20	C10	C16	C20
60A	220μs	6pcs	9pcs	12pcs	10pcs	16pcs	20pcs

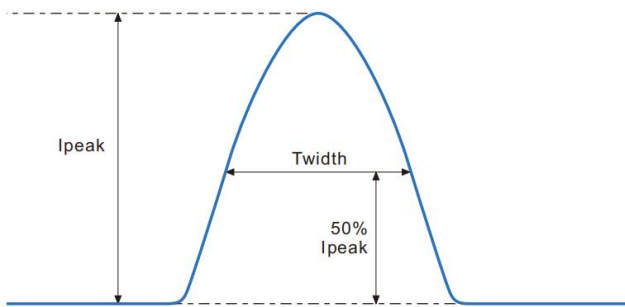

Remarks:

- 1.The number of drives mounted under different MCBs in the table is the maximum value. Please do not exceed this number during installation.
- 2.Different brands and models of miniature circuit breakers, the number of drives mounted will be slightly different.

◆ Parameter

Number	Output				Switch position		
	Current (mA)	Voltage (VDC)	Voltage No load (VDC)	Power (W)	1	2	3
1	1150mA	15-51VDC	59	58.7	--	--	--
2	1200mA			61.2	ON	--	--
3	1250mA			63.8	--	ON	--
4	1300mA			66.3	ON	ON	--
5	1350mA			68.9	--	--	ON
6	1400mA			71.4	ON	--	ON
7	1450mA			74	--	ON	ON
*8	1500mA	15-50VDC		75	ON	ON	ON

* Factory default

◆ Wiring diagram

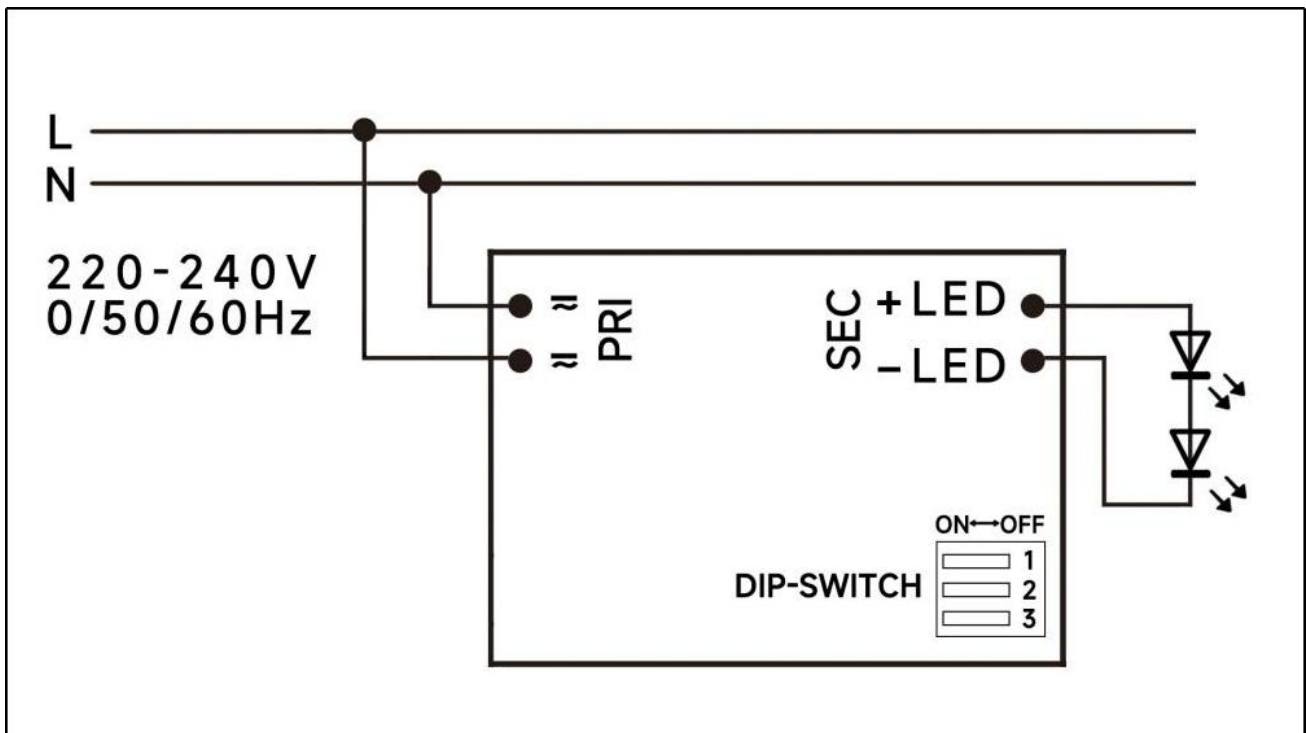

◆ 2D diagram

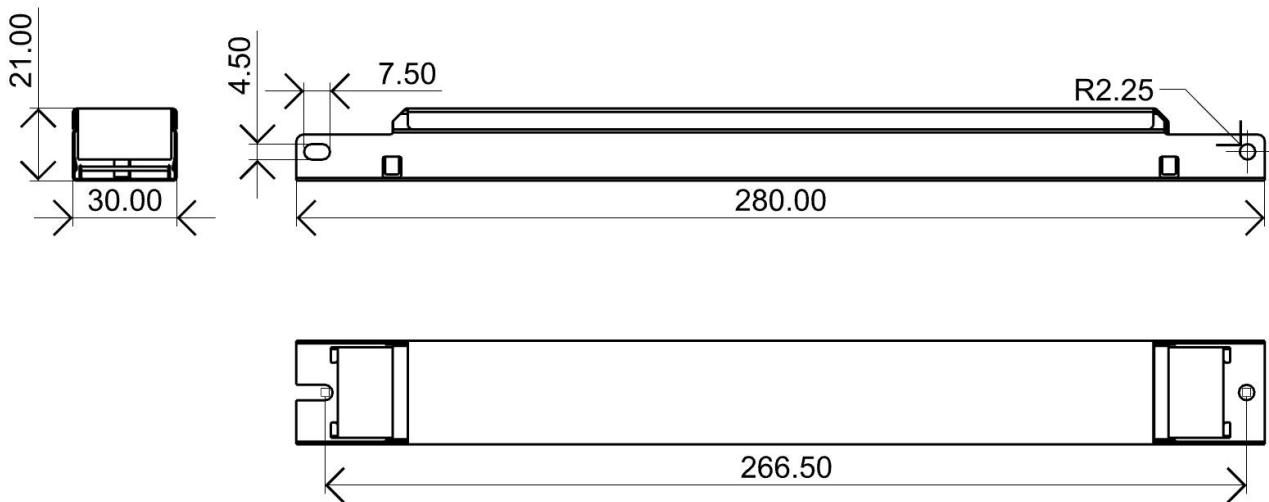

◆ Wiring & Connections

Specification item		Value (Unit)
Input	Input wire cross-section	0.5...1.5 mm ² (With side caps: 0.75...1.5 mm ²)
	Input wire gauge.	16...20 AWG (With side caps: 16...22 AWG)
	Input wire strip length	7...9mm
Output	Output wire cross-section	0.5...1.5 mm ²
	Output wire gauge.	16...20 AWG
	Output wire strip length	7...9mm

◆ Curve for FMS-75-1500 LD EXC, $I_o=1500mA$

Lifetime vs. Temperature Curve

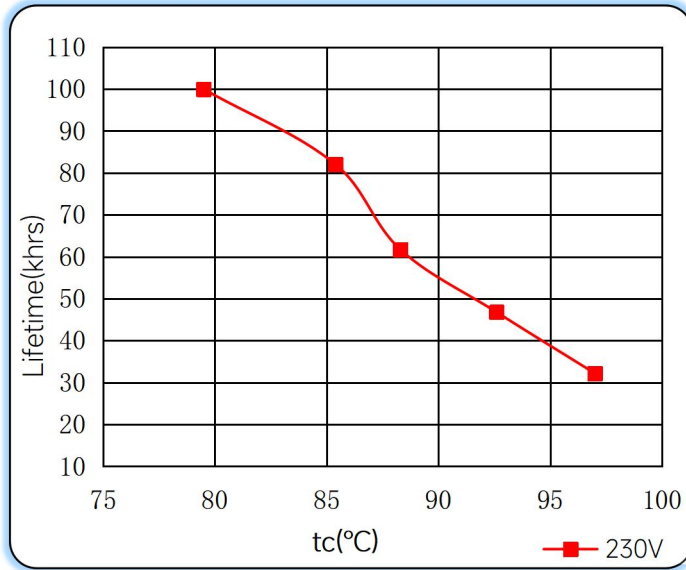

Efficiency vs. Load

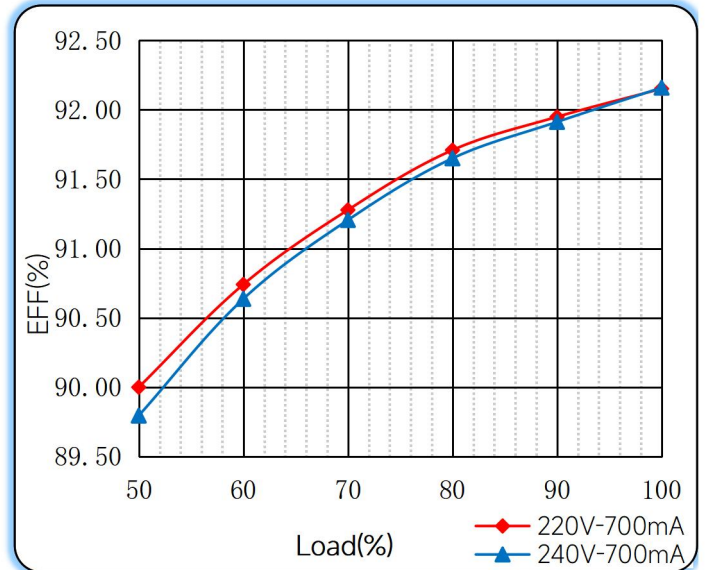

Power Factor Characteristics

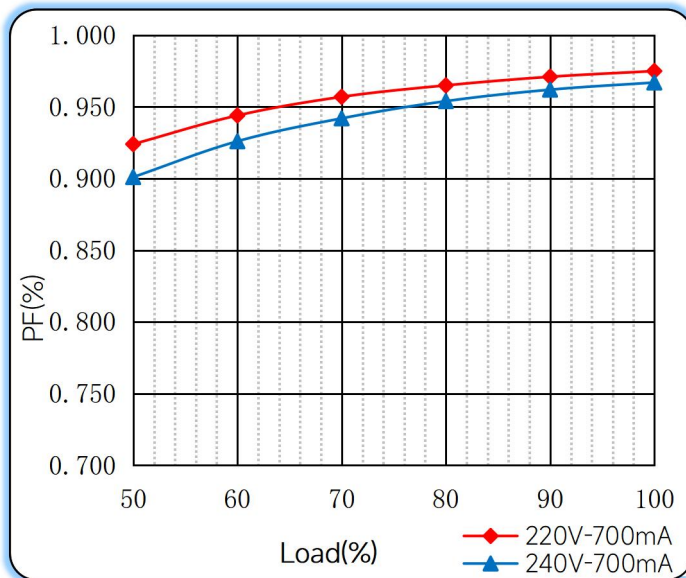

THD vs. Load

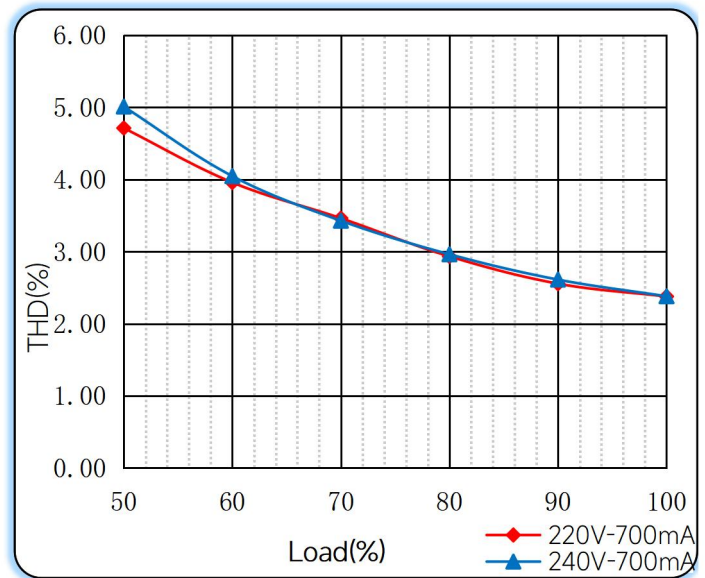

◆ Operating window

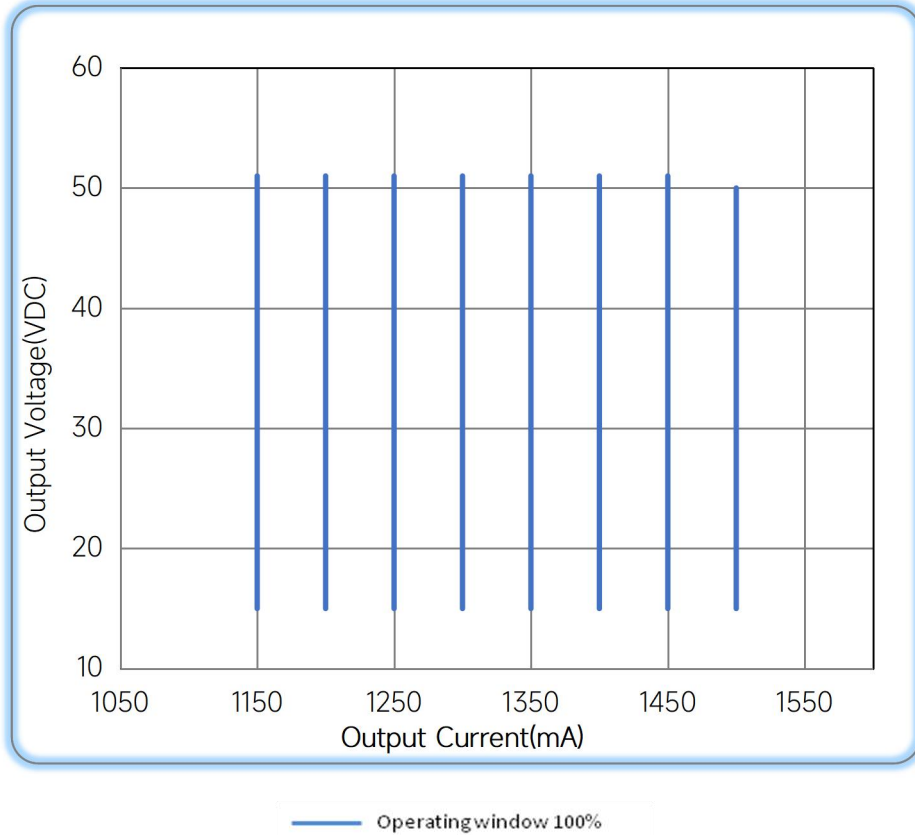

◆ Revision Updates

ITEM	BEFORE	AFTER	VERSION	DATE
Initial			A	2023/08/15

Remark: The final interpretation of the contents of the specification belongs to Eaglerise Electric & Electronic (China) Co., Ltd.

Tel: +86-0757-86256822, +86-0757-86256831
 E-mail: sales@eaglerise.com
 Website : <https://lighting.eaglerise.com>



EAGLERISE



Manual