

44W 0-10V+RX+PWM Dimming power supply

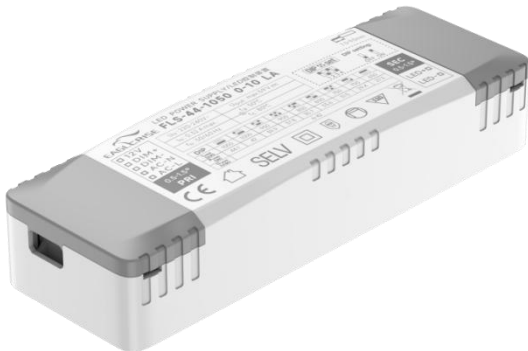

■ **Approve**



◆ **Description**

FLS-44-1050 0-10 LA is a 44W constant current LED driver that operates from 198-264Vac input with 650 to 1050mA output current and a forward voltage range from 9 to 42Vdc. The output current is adjustable by DIP Switch. With it's compact dimensions from 138 x 45 x 28mm. It is easy to integrate in LED Panel and down light products. To ensure trouble-free operation, protection is provided against output short circuit and over Load.

◆ **Model code**

FLS-44-1050 0-10 LA

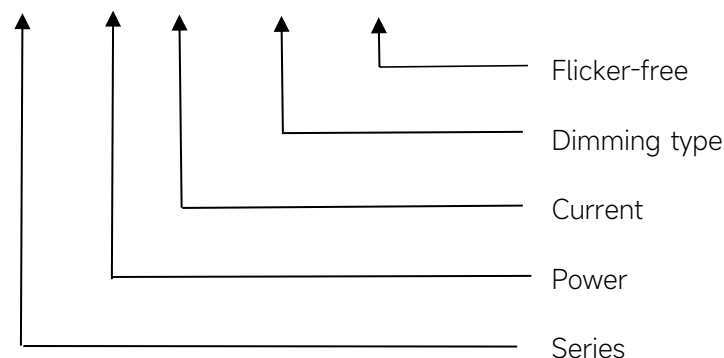

Features

- For luminaries of protection
- Class I, II, SELV, Independent
- Input Voltage 220-240VAC
- Protections: SCP/OLP/OVP/OTP
- Power Factor : 0.6C-0.97
- Efficiency: ≥85%
- Support 0-10V,RX,PWM Dimming
- 5 years warranty

Applications

- LED panel light, Down light

◆ Specification

Output	Constant Current (mA)	650	700	750	800	850	900	950	1000	1050	
	Voltage Range(VDC)	9-42VDC									
	Unload voltage Max.(VDC)	59VDC									
	Current Accuracy	±7%									
	Output HF current ripple(≥1KHz)	±5%									
	Output LF current ripple(≤120Hz)	±3%									
	Auxiliary Output Voltage	12V									
	Auxiliary Output Current	50 mA									
	SVM	≤0.4									
	Pst	≤1									
	Standby Power	≤0.5W									
	Efficiency(Typ.)	≥85%@Full load									
Input	Rated input voltage(VAC)	220-240VAC									
	Range of input voltage(VAC)	198-264VAC									
	Frequency(Hz)	50/60 Hz									
	Displacement factor	≥0.9@Full load									
	Power Factor	0.6C-0.97									
	Input Current max	0.32 A Max									
	Start-up time	< 0.5S									
	No Load Power	≤0.5W									
	THD (Typ.)	≤10%@full load									
Dimming	Dimming	YES									
	Dimming mode	0-10V,RX,PWM									
	Dimming depth	1%									
	Dimming current range	1-100%									
Protection	Over Load Protection	103-120%									
	Over Voltage Protection	> 59VDC									
	Short circuit Protection	YES/auto Resume									
	Over Temperature Protection	YES/Auto Resume									
Environment	Operating Temperature	-20°C...+45°C									
	Humidity	20%-90%RH									
	Tc	85°C									
	Storage Temperature	-25°C...+80°C									
	Life time	> 50000h@Tc=80°C									
Surface	Dimension	138 x 45 x 28(LXWXH)mm									

standards	EN 61547; EN 61347-1,EN 61347-2-13; IEC 61347-1,IEC 61347-2-13; GB 19510.1,GB 19510.14; AS 61347.1,AS 61347.2.13; EN 62384; EN IEC 55015,EN IEC 61000-3-2,EN 61000-3-3; GB/T 17743,GB 17625.1	
Others	ErP	EU 2019/2020
	RoHS	RoHS (2011/65/EU) (EU)2015/863
Note	1.All parameters not specially mentioned are measured at 230VAC input , full load and 25°C of ambient temperature. 2.Ripple & Noise are measured at 20MHz of bandwidth by using a 300mm twisted pair-wire terminated with a 0.1uF & 47 uF parallel capacitor. 3.Switch and dimmer are not recommended to connect between this product output and luminaries.	

◆ Parameter

Number	Output				Switch position			
	Current (mA)	Voltage (VDC)	Voltage No load (VDC)	Power (W)	1	2	3	4
1	650mA	9-42VDC	59VDC	27.3	--	--	--	--
2	700mA			29.4	--	--	--	ON
3	750mA			31.5	--	--	ON	--
4	800mA			33.6	--	--	ON	ON
5	850mA			35.7	--	ON	--	--
6	900mA			37.8	--	ON	--	ON
7	950mA			39.9	--	ON	ON	--
8	1000mA			42	--	ON	ON	ON
*9	1050mA			44.1	ON	ON	ON	ON

* Factory default

◆ Circuit Breaker

I ^{peak}	T _{width}	B10	B16	B20	C10	C16	C20
11.7A	120μs	25pcs	40pcs	50pcs	25pcs	40pcs	50pcs

◆ **Wiring diagram**

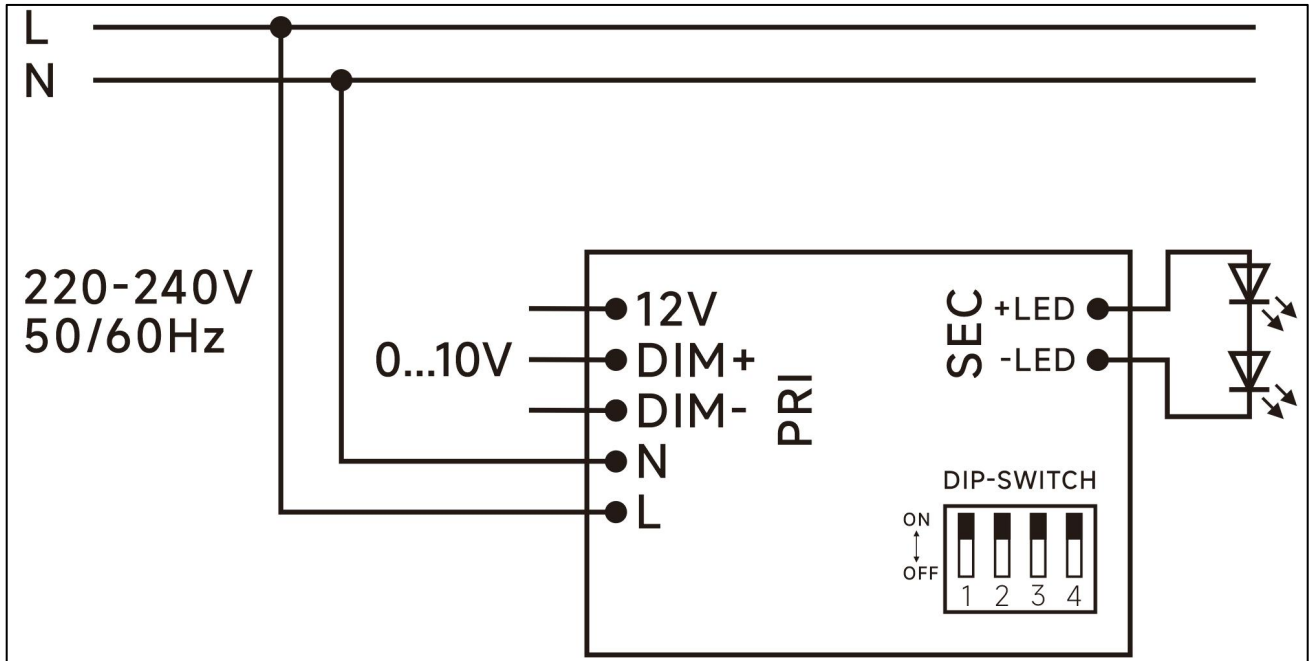

◆ **The dimming curve**

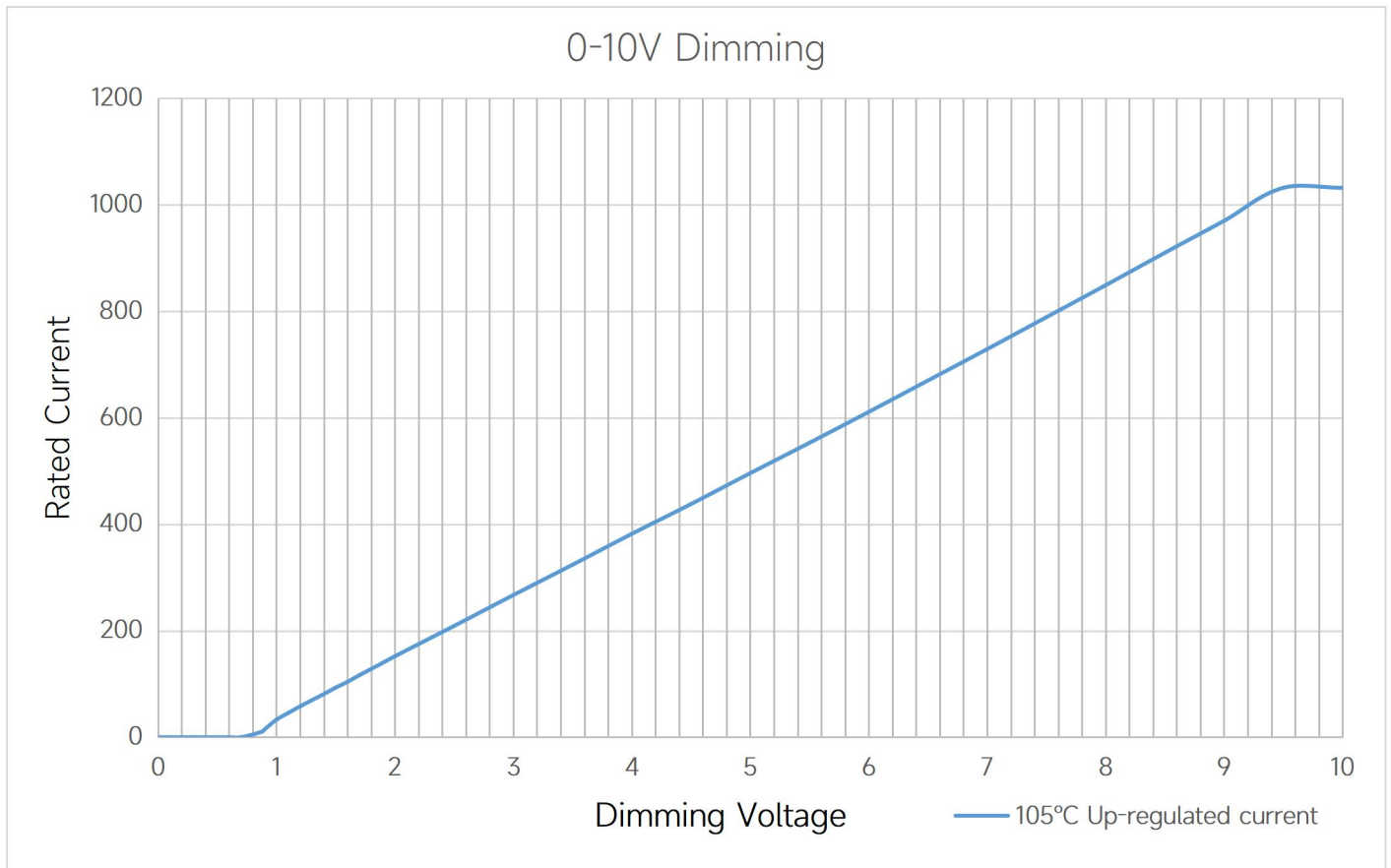

◆ **2D diagram**

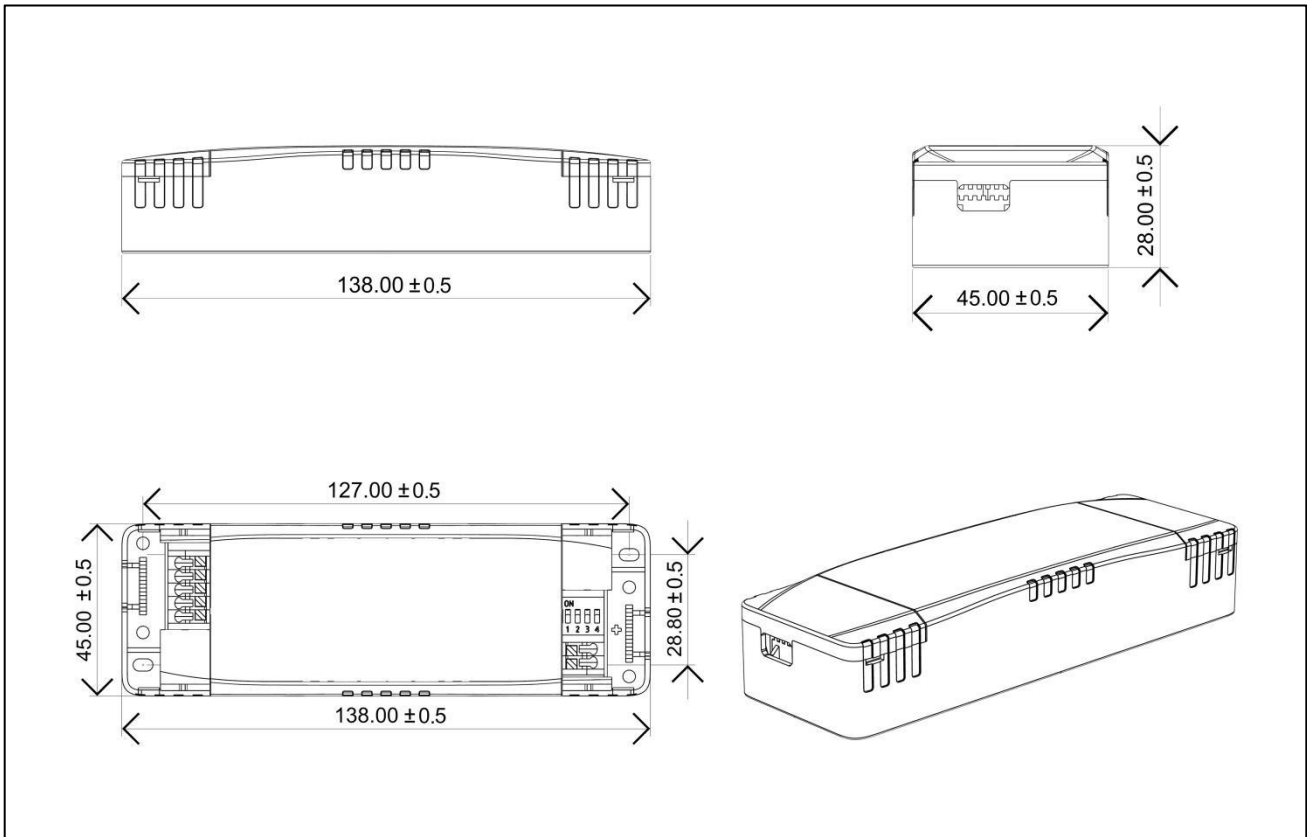

◆ **Wiring & Connections**

Specification item		Value (Unit)
Input	Input wire cross-section	0.5...1.5 mm ²
	Input wire gauge.	16...20 AWG
	Input wire strip length	7...9mm
Output	Output wire cross-section	0.5...1.5 mm ²
	Output wire gauge.	16...20 AWG
	Output wire strip length	7...9mm

◆ **Curve for FLS-44-1050 0-10 LA, I_o=1050mA**

Lifetime vs. Temperature Curve

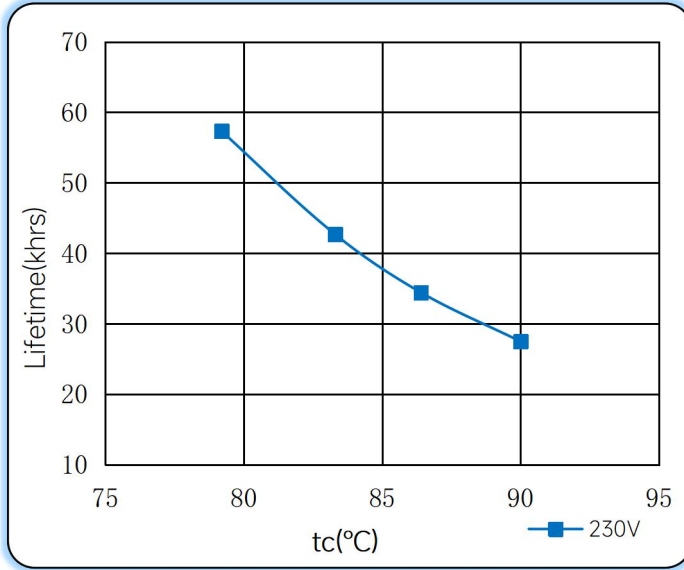

Efficiency vs. Load

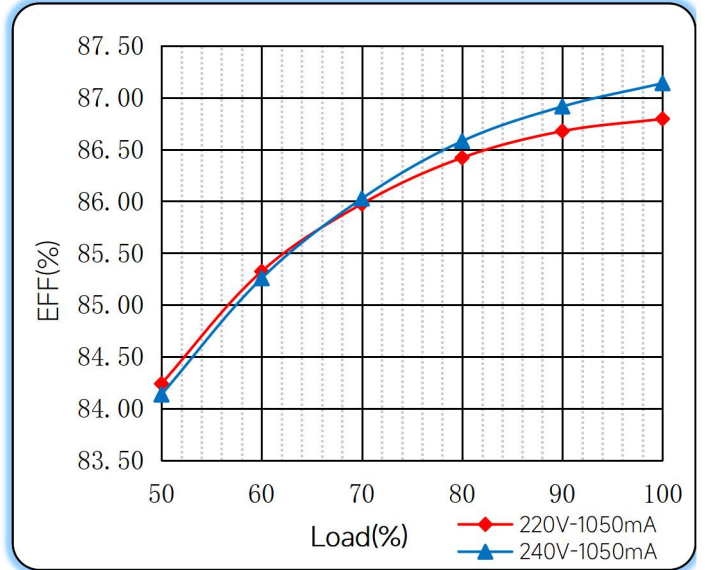

Power Factor Characteristics

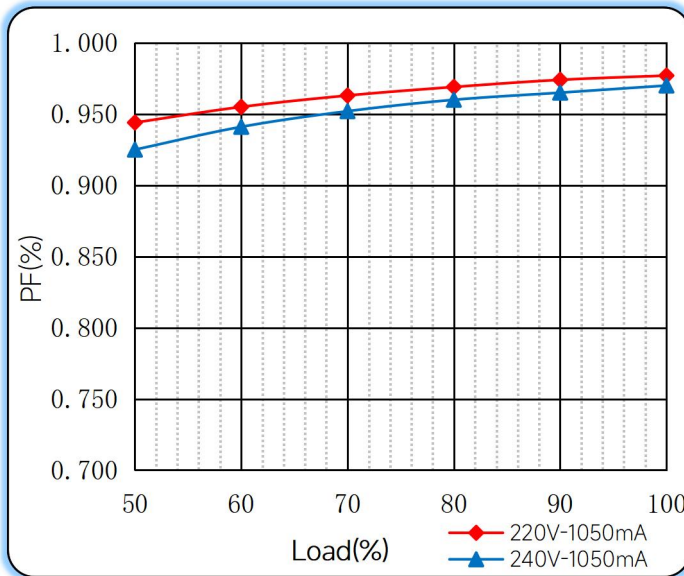

THD vs. Load

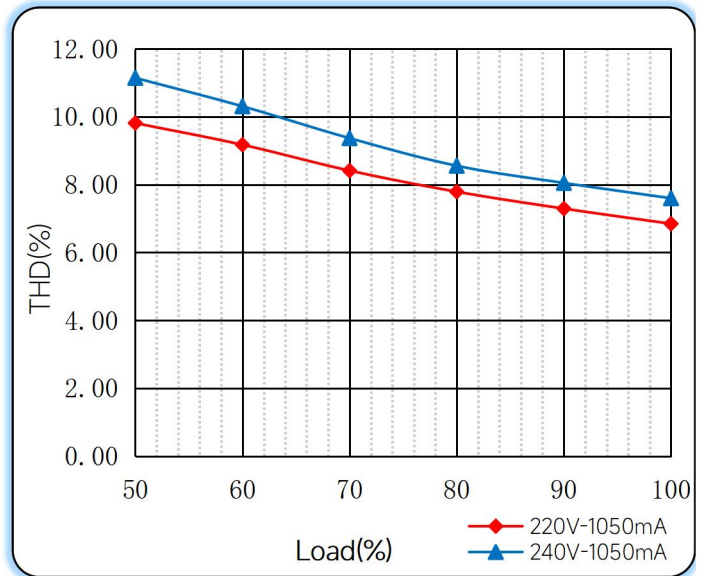

◆ Operating window

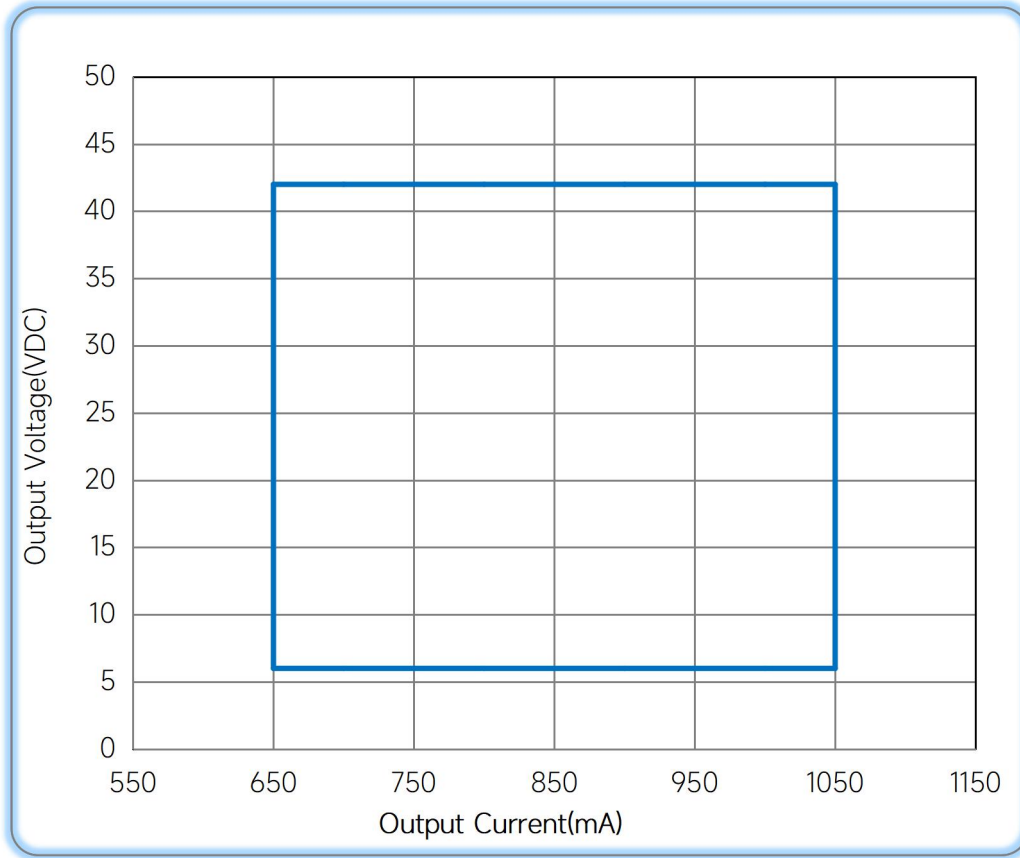

— Operating window 100%

◆ Revision Updates

ITEM	BEFORE	AFTER	VERSION	DATE
Initial			A	2023/01/04
Current Accuracy	±7%	±5%	B	2023/03/18

Tel: +86-0757-86256822, +86-0757-86256831

E-mail: sales@eaglerise.com

Website : <https://lighting.eaglerise.com>



EAGLERISE



Manual