

## 60W Constant Current - DIP-Switch



### Features

- For luminaries of protection Class I or II, SELV, built-in
- Input Voltage : 220-240VAC
- Protections: SCP/OLP/OVP/OTP
- Power Factor : > 0.95
- Efficiency : ≥90%
- 5 years warranty

### Applications

- Linear light

■ Approve



### ◆ Description

FMS-60-1500 LD EXC is a 60W constant current LED driver that operates from 198-264Vac input with 1150 to 1500mA output current. The output current is selectable by DIP Switch. With it's dimensions from 280 x 30 x 21mm. It is easy to integrate in linear light products. To ensure trouble-free operation, protection is provided against output short circuit, over Load and over temperature.

### ◆ Model code

#### FMS-60-1500 LD EXC

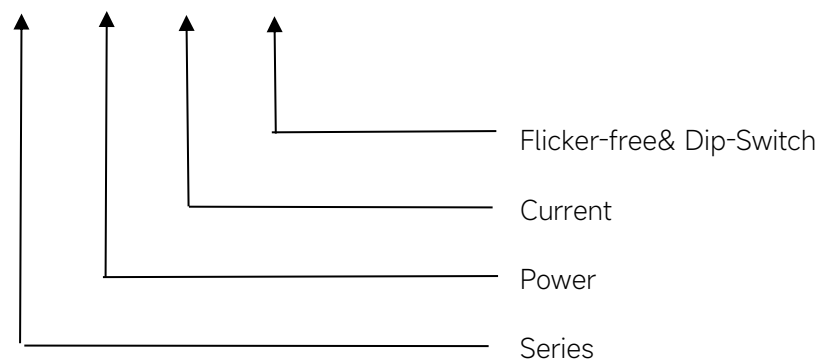

## ◆ Specification

Output	Constant Current	1150mA	1200mA	1250mA	...	1450mA	1500mA
	Voltage Range	15-51VDC	15-50VDC	15-48VDC	...	15-42VD	15-40VDC
	Unload voltage Max.	59VDC					
	Current Accuracy	±5%					
	Output HF current ripple(≥1KHz)	±3%					
	Output LF current ripple(≤120Hz)	±3%					
	SVM	≤0.4					
	Pst	≤1					
	Efficiency(Typ.)	90%					
Input	Rated input voltage	220-240V					
	Range of input voltage	198-264VAC					
	Maximum voltage	300VAC@1 h maximum,unit might not operate in this abnormal condition					
	Range of input voltage(VDC)	176-280VDC					
	Frequency(Hz)	0/50/60 Hz					
	Power Factor	>0.95					
	Input Current max	0.38A					
	Start-up time	< 0.5S					
	No Load Power	≤0.5W					
	THD (Typ.)	< 10%.					
Protection	Over Load Protection	103-150%					
		YES/Auto Resume					
	Over Voltage Protection	> 59VDC					
		YES/Auto Resume					
Short circuit Protection	YES/Auto Resume						
Over Temperature Protection	YES/Auto Resume						
capability	Surge capability (L-N)	2KV					
	Surge capability (L/N-Ground)	2KV					
Environment	Operating Temperature	-20°C~+60°C					
	Humidity	20%-90%RH					
	Tc	90°C					
	Storage Temperature	-25°C~+80°C					
	Life time	> 50000h@Tc=85°C,230VAC					
	Noise	≤25dB(A)@20cm					
Surface	Dimension	280X30X21(LXWXH)mm					
	material	metal case					
Standards	Safety	GB19510. 1, GB19510. 14;IEC61347- 1, IEC61347-2- 13;EN61347- 1, EN61347-2-13;EN62384					

	EMC	GB/T17743, GB17625. 1;EN55015, EN61000-3-2, EN61000-3-3, EN61547;EN61000-4-5;
	ErP	Erp2.0 EU 2019/2020
	RoHS	RoHS (2011/65/EU) (EU)2015/863
Note	<p>1.All parameters NOT specially mentioned are measured at 230VAC input , full load and 25°C of ambient temperature.</p> <p>2.Ripple &amp; Noise are measured at 20MHz of bandwidth by using a 300mm twisted pair-wire terminated with a 0.1uF &amp; 47 uF parallel capacitor.</p> <p>3.The DC input for this product is only used for emergency lighting and applies to functional and safety requirements, EMC is not considered..</p> <p>4.EL compatible with IEC 61347-2-13 Annex J, compatible with EN 60598-2-22 emergency lighting fixtures, compatible with EN 50172 central battery system applications.</p> <p>5.The over-temperature protection of the product is provided by the IC.</p> <p>6.All Eaglerise power supply are complied with EMI regulations. Since they are belong to component and will be installed inside system enclosure. When they are integrated into a system, the EMI characteristics of the system must be re-verified again.</p>	

## ◆ Inrush Current

I <sub>peak</sub>	T <sub>width</sub>	B10	B16	B20	C10	C16	C20
36.7A	188μs	11pcs	19pcs	23pcs	19pcs	31pcs	39pcs

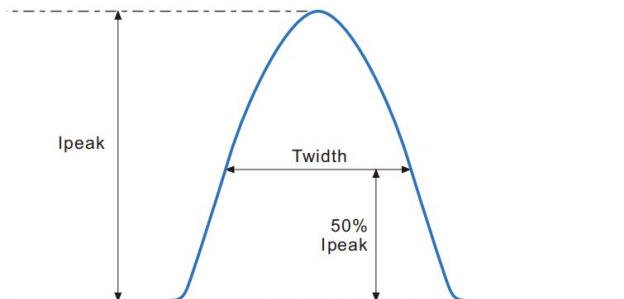

### Remarks:

- 1.The number of drives mounted under different MCBs in the table is the maximum value. Please do not exceed this number during installation.
- 2.Different brands and models of miniature circuit breakers, the number of drives mounted will be slightly different.

### ◆ Parameter

Number	Output				Switch position		
	Current (mA)	Voltage (VDC)	Voltage No load (VDC)	Power (W)	1	2	3
1	1150mA	15-51VDC	59	58.7	--	--	--
2	1200mA	15-50VDC		60	ON	--	--
3	1250mA	15-48VDC		60	--	ON	--
4	1300mA	15-46VDC		59.8	ON	ON	--
5	1350mA	15-45VDC		60.8	--	--	ON
6	1400mA	15-42VDC		58.8	ON	--	ON
7	1450mA	15-42VDC		60.9	--	ON	ON
*8	1500mA	15-40VDC		60	ON	ON	ON

\* Factory default

### ◆ Wiring diagram

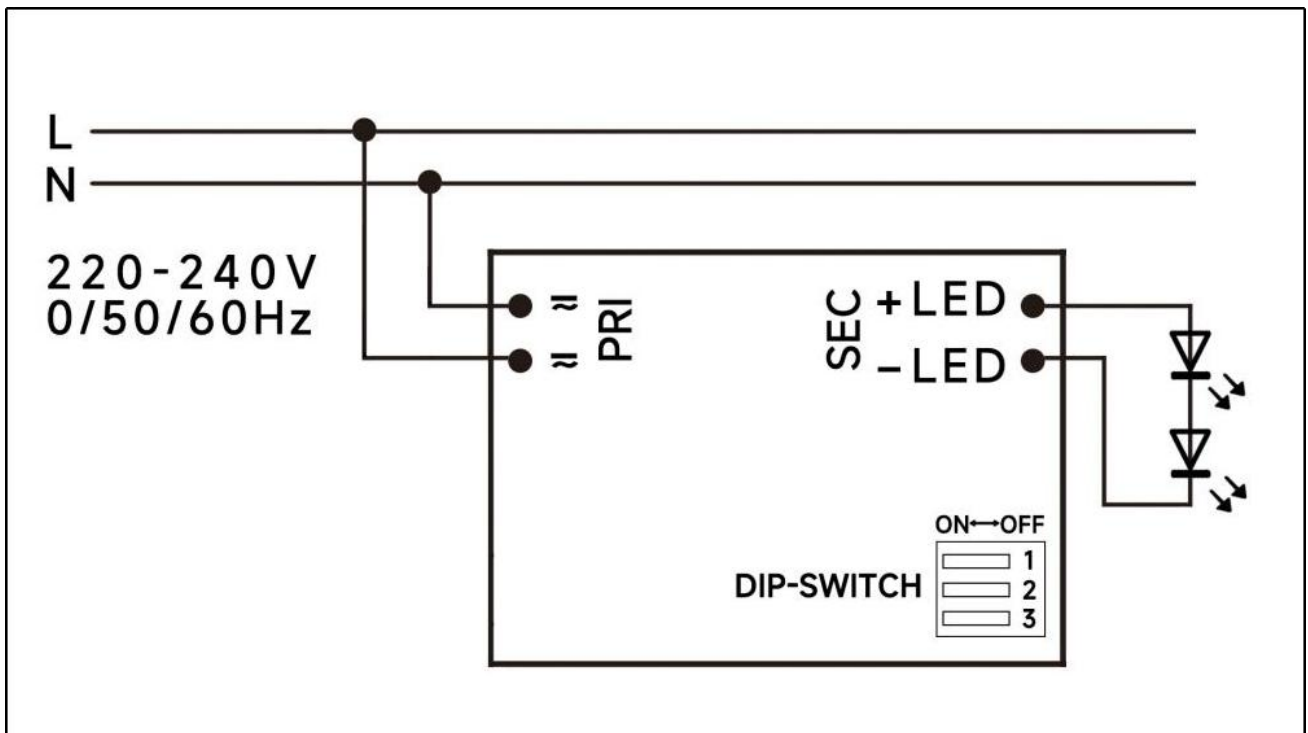

### ◆ 2D diagram

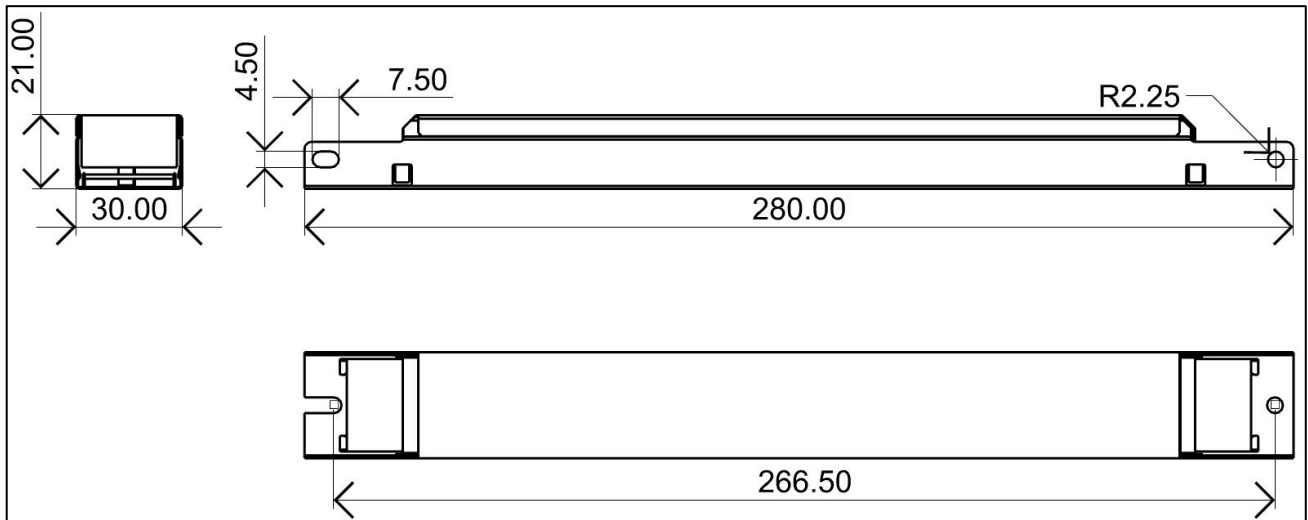

### ◆ Wiring & Connections

	Specification item	Value (Unit )
Input	Input wire cross-section	0.5...1.5 mm <sup>2</sup> (With side caps: 0.75...1.5 mm <sup>2</sup> )
	Input wire gauge.	16...20 AWG (With side caps: 16...22 AWG )
	Input wire strip length	7...9mm
Output	Output wire cross-section	0.5...1.5 mm <sup>2</sup>
	Output wire gauge.	16...20 AWG
	Output wire strip length	7...9mm

Note: Solid wire is risky to use on an angled terminal. Stranded wire is recommended for this kind of use.

## ◆ Curve for FMS-60-1500 LD EXC, $I_o=1500mA$

### Lifetime vs. Temperature Curve

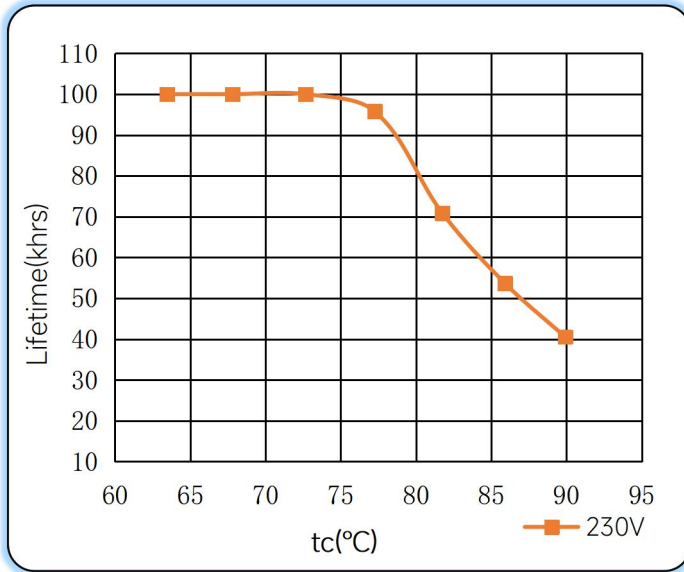

### Efficiency vs. Load

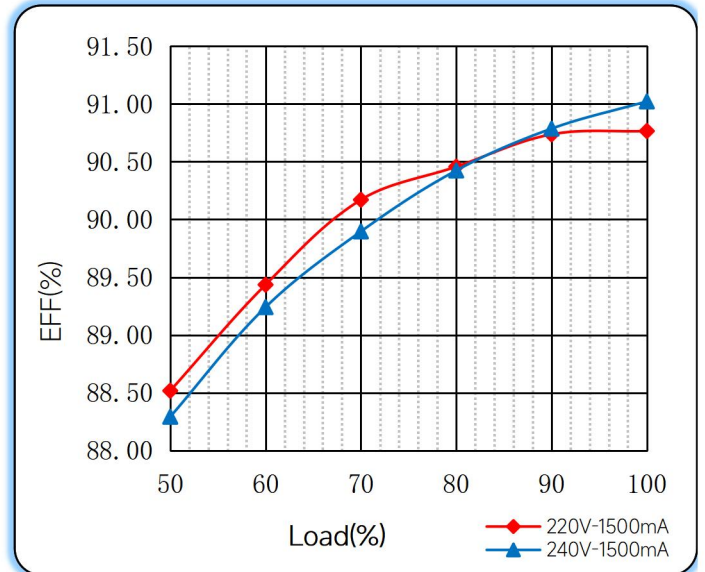

### Power Factor Characteristics

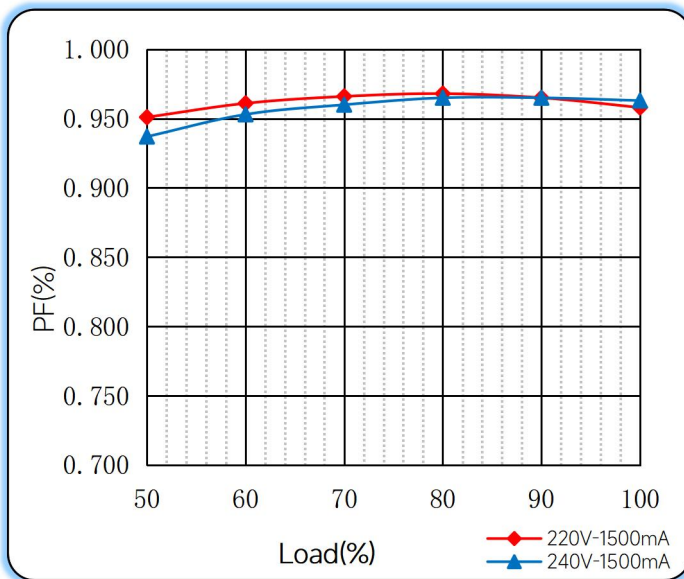

### THD vs. Load

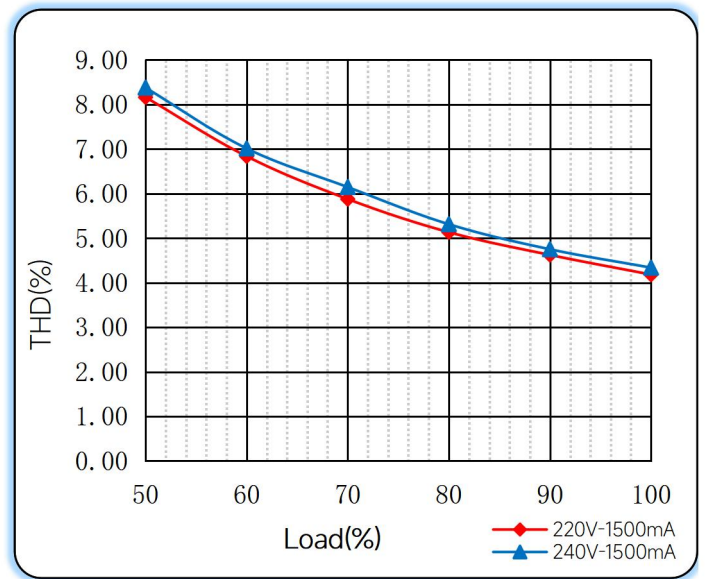

## ◆ Operating window

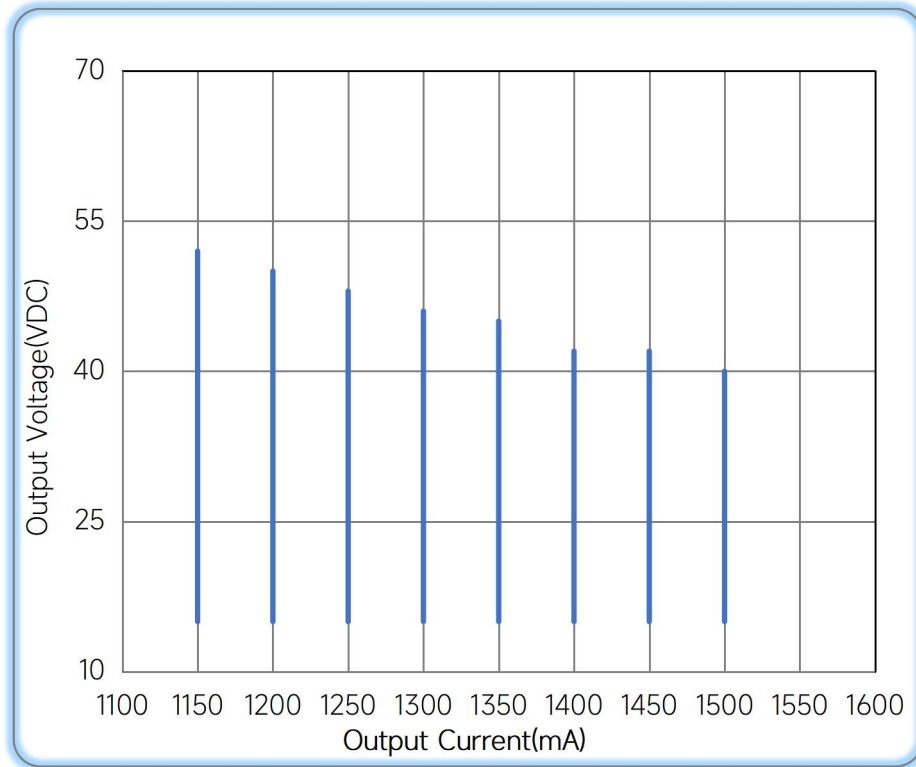

— Operating window 100%

## ◆ Revision Updates

ITEM	BEFORE	AFTER	VERSION	DATE
Initial			A	2023/08/15
Voltage Range	15-54	15-51	B	2024/04/18
Tc	85°C	90°C	C	2024/05/15

Remark: The final interpretation of the contents of the specification belongs to Eaglerise Electric & Electronic (China) Co., Ltd.

Tel: +86-0757-86256822, +86-0757-86256831

E-mail: sales@eaglerise.com

Website : <https://lighting.eaglerise.com>



EAGLERISE



Manual