

30W Constant Current -FDS power supply



■ Approve



Features

- Class II, SELV, built-in
- Input Voltage 220-240VAC
- Protections: SCP/OLP/OVP
- Power Factor: >0.9@550-650mA
>0.95@700mA
- Efficiency: ≥88%
- Adjustable Output Current with dip-switch
- 5 years warranty
- IP20

Applications

- Track Spot light

◆ Description

FDS-30-700 LD2 is a 30W constant current LED driver that operates from 198-264Vac input with 550 to 700 mA output current and a forward voltage range from 27 to 42Vdc. The output current is adjustable by DIP Switch. With its compact dimensions from 161.8 x 30.6 x 44.5 mm it is easy to integrate in track spot light products. To ensure trouble-free operation, protection is provided against output short circuit and over Load.

◆ Model code

FDS-30-700 LD2

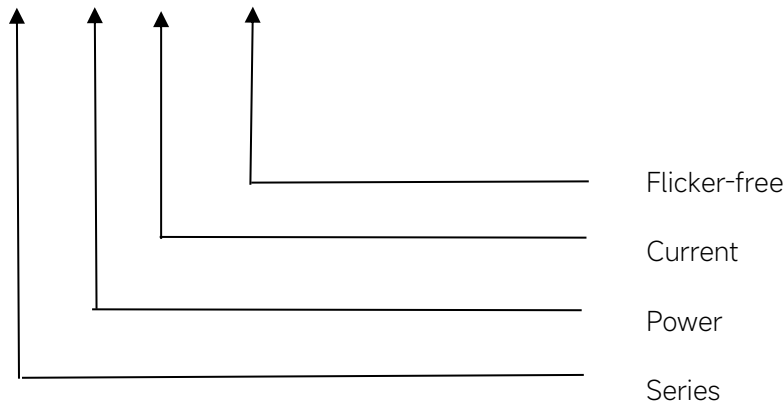

◆ Specification

| | | | | | |
|-----------------------------|------------------------------------------------------------------------------------------------------------------------------------------------------------------------------------------------------------------------------------------------------------------|--------------------------------|----------|-----|----------|
| Output | Constant Current | 550mA | 600mA | ... | 700mA |
| | Voltage Range | 27-42VDC | 27-42VDC | ... | 27-42VDC |
| | Unload voltage Max. | 55VDC | 55VDC | ... | 55VDC |
| | Current Accuracy | ±7% | | | |
| | Output HF current ripple(≥1KHz) | ±5% | | | |
| | Output LF current ripple(≤120Hz) | ±5% | | | |
| | SVM | ≤0.4 | | | |
| | P _{st} | ≤1 | | | |
| Input | Efficiency(Typ.) | ≥88%@Full load | | | |
| | Rated input voltage | 220-240VAC | | | |
| | Range of input voltage | 198-264VAC | | | |
| | Range input voltage(DC) | 198-280VDC | | | |
| | Frequency(Hz) | 0/50/60 Hz | | | |
| | Displacement factor | ≥0.9 | | | |
| | Power Factor | 0.85C-0.95@230VAC, full load | | | |
| | Input Current max | 0.22A MAX. | | | |
| | Start-up time | < 0.5S | | | |
| | No Load Power | ≤0.5W | | | |
| Protection | THD (Typ.) | <10% @Full Load,240VAC | | | |
| | Over Load Protection | 103-120% | | | |
| | | YES/Auto Resume | | | |
| | Over Voltage Protection | > 55VDC | | | |
| YES/Auto Resume | | | | | |
| Short circuit Protection | YES/Auto Resume | | | | |
| Over Temperature Protection | YES/Auto Resume | | | | |
| Environment | Operating Temperature | -20°C~+35°C | | | |
| | Humidity | 10%-90%RH | | | |
| | T _c | 70°C | | | |
| | Storage Temperature | -20°C~+60°C | | | |
| | Life time | > 50000h@T _c =70°C | | | |
| Surface | Dimension | 161.8X30.6X44.5(LXWXH)mm | | | |
| Standards | EN 61347-1,EN 61347-2-13(CE-LVD,ENEC); IEC 61347-1,IEC 61347-2-13(CB); EN 62384(ENEC) EN IEC 55015,EN IEC 61000-3-2,EN 61000-3-3(CE-EMC,RCM)EN 61547(CE-EMC,RCM) | | | | |
| Others | ErP | EU 2019/2020 | | | |
| | RoHS | RoHS (2011/65/EU) (EU)2015/863 | | | |
| Note | 1.All parameters NOT specially mentioned are measured at 230VAC input , full load and 25°C of ambient temperature. 2.Ripple & Noise are measured at 20MHz of bandwidth by using a 300mm twisted pair-wire terminated with a 0.1uF & 47 uF parallel capacitor. | | | | |

◆ Parameter

| Number | Output | | | | Switch position | |
|--------|-----------------------|---------------|-----------------------|-----------|-----------------|----|
| | Current (mA) I1+I2 | Voltage (VDC) | Voltage No load (VDC) | Power (W) | 1 | 2 |
| 1 | 550mA | 27-42 | 55 | 23.1 | -- | -- |
| 2 | 600mA | | | 25.2 | ON | -- |
| 3 | 650mA | | | 27.3 | -- | ON |
| 4 | 700mA | | | 29.4 | ON | ON |

* Factory default

◆ Inrush Current

| I ^{peak} | T ^{width} | B10 | B16 | B20 | C10 | C16 | C20 |
|-------------------|--------------------|-------|-------|-------|-------|-------|-------|
| 30A | 110μs | 25pcs | 41pcs | 51pcs | 36pcs | 58pcs | 72pcs |

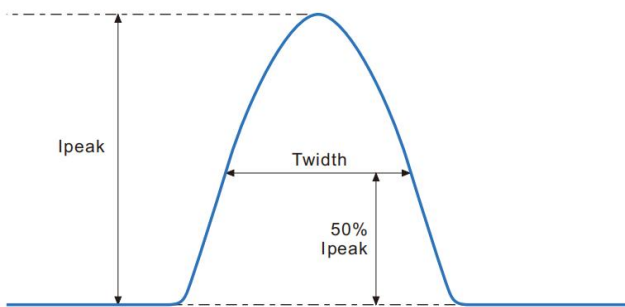

Remarks:

- 1.The number of drives mounted under different MCBs in the table is the maximum value. Please do not exceed this number during installation.
- 2.Different brands and models of miniature circuit breakers, the number of drives mounted will be slightly different.

◆ **Wiring diagram**

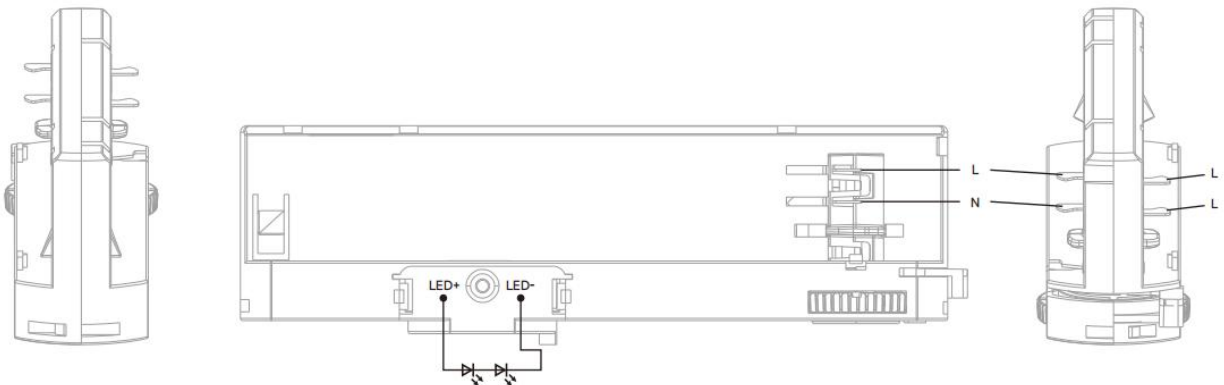

◆ **2D diagram**

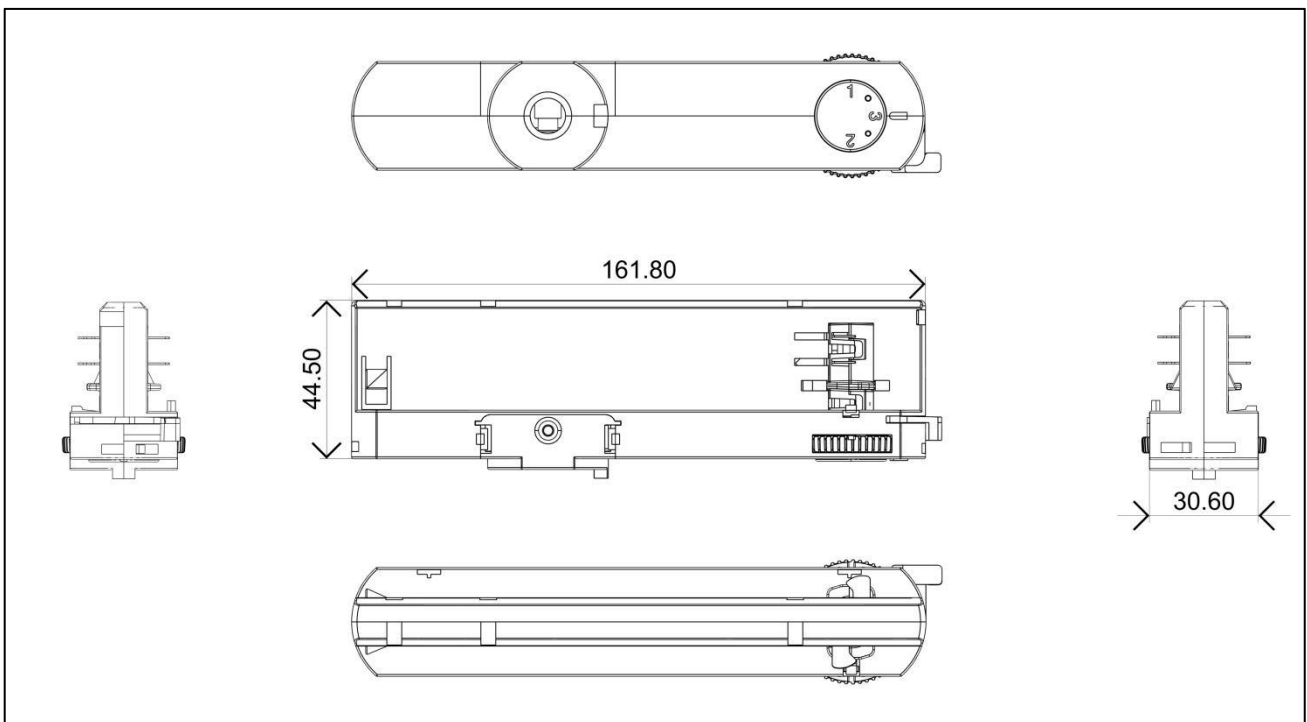

◆ Matching brand

| | | |
|-------|------------|----------------|
| Brand | IVELA | 7501 |
| | STUCCHI | 9000XX Series |
| | POWERGEAR | PRO-0431 |
| | GLOBAL | XTS 4 & XTSF 4 |
| | Unipro | T32B |
| | JBD | H-04 |
| | GUANG FA | GF016 |
| | JIN HAOTAI | 4 wires |

◆ Matching description

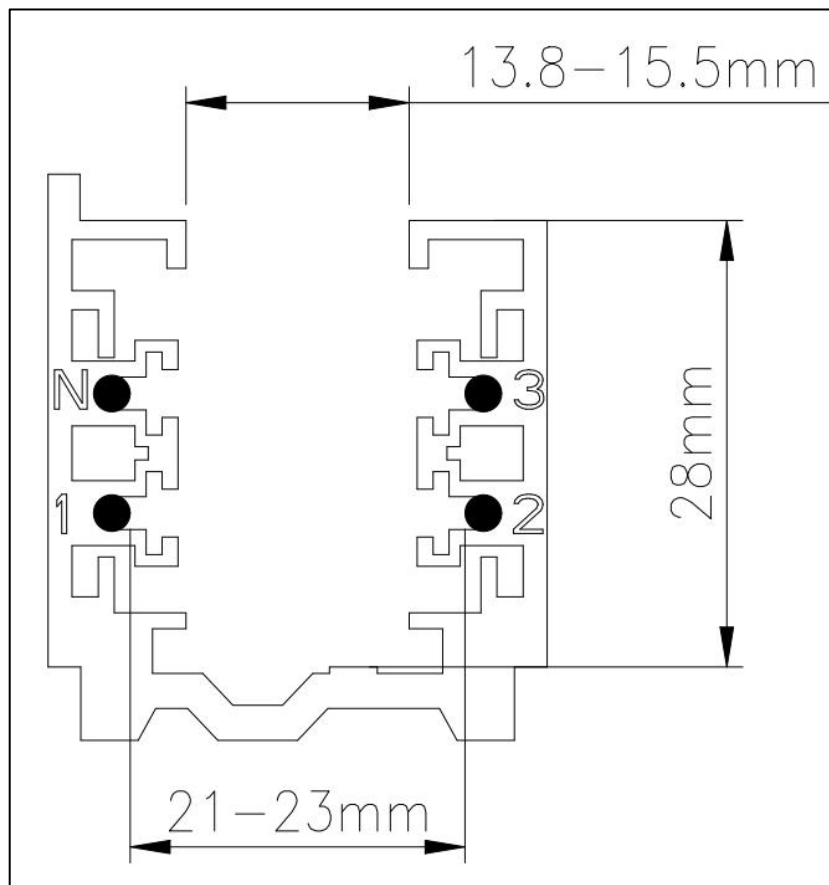

◆ Curve for FDS-30-700 LD2, I_o=700mA

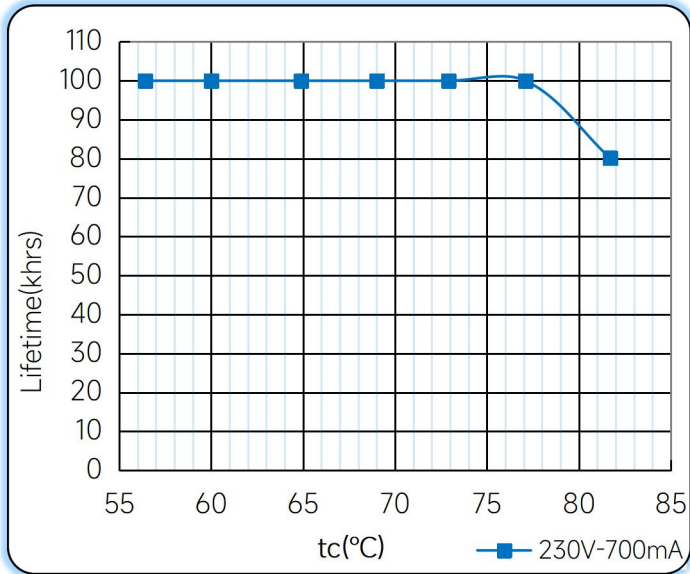
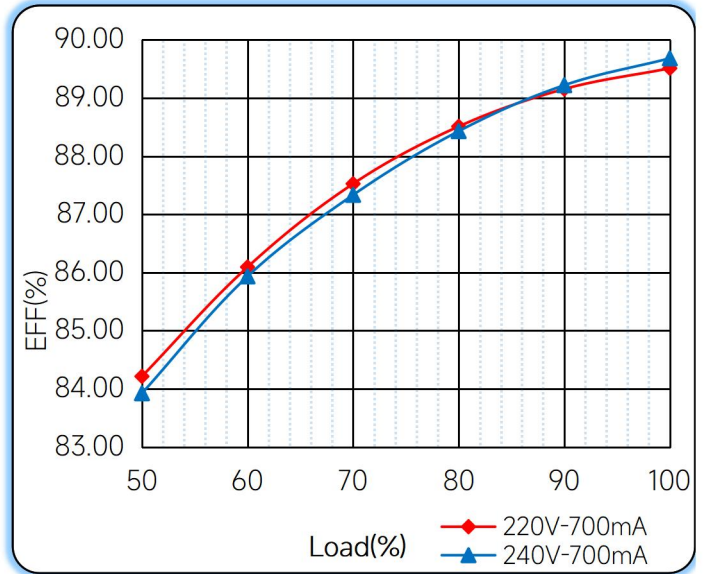
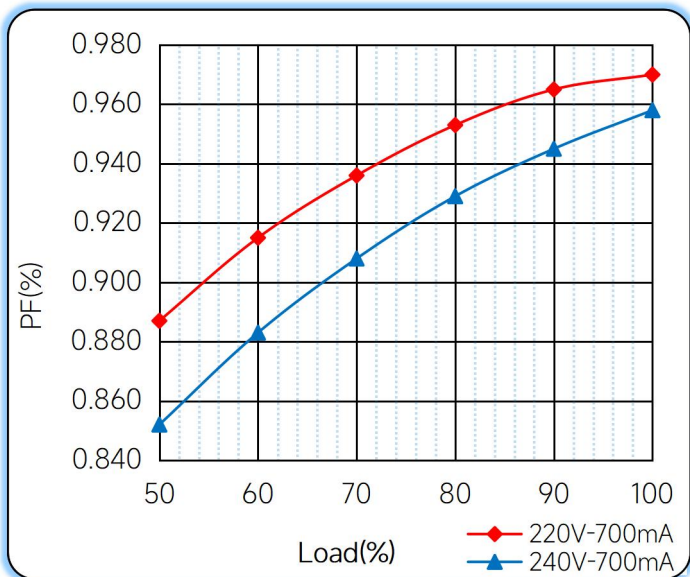
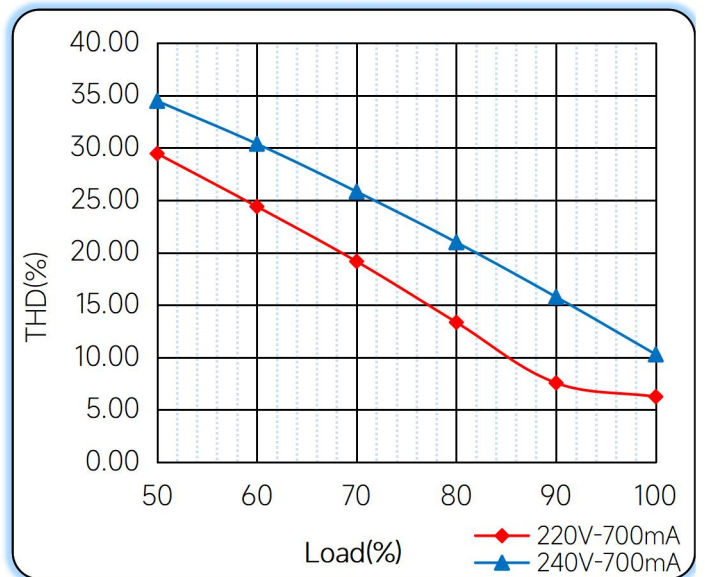
Lifetime vs. Temperature Curve

Efficiency vs. Load

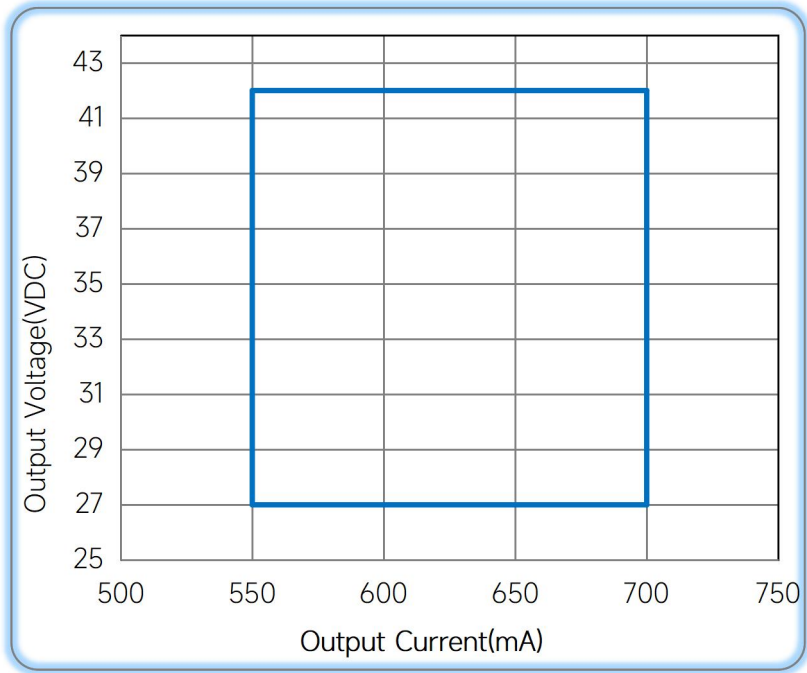
Power Factor Characteristics

THD vs. Load

◆ Operating window



— Operating window 100%

◆ Revision Updates

| ITEM | BEFORE | AFTER | VERSION | DATE |
|---------|--------|------------------------------|---------|------------|
| Initial | | | A | 2022/10/24 |
| PF | | 0.85C-0.95@230VAC, full load | B | 2023/07/22 |

Tel: +86-0757-86256822, +86-0757-86256831

E-mail: sales@eaglerise.com

Website : <https://lighting.eaglerise.com>



EAGLERISE



Manual