

60W Constant Current -FMS Series



■ Approve



Features

- Class I , Non-isolated, Built-in
- Input Voltage :220-240VAC
- Protections: SCP/OLP/OVP/OTP
- Power Factor: 0.95(Typ.)
- Efficiency: $\geq 92\%$ (Typ.)
- Adjustable Output Current with dip-switch
- 5 years warranty
- IP20

Applications

- Linear light

◆ Description

FMS-60-350 N-S LD1 E is a 60W constant current LED driver that operates from 198-264Vac input with 200 to 350mA output current. The output current is adjustable by DIP Switch. With it's dimensions from 190 x 30 x 21mm. It is easy to integrate in linear light products. To ensure trouble-free operation, protection is provided against output short circuit, over voltage and over temperature.

◆ Model code

FMS-60-350 N-S LD1 E

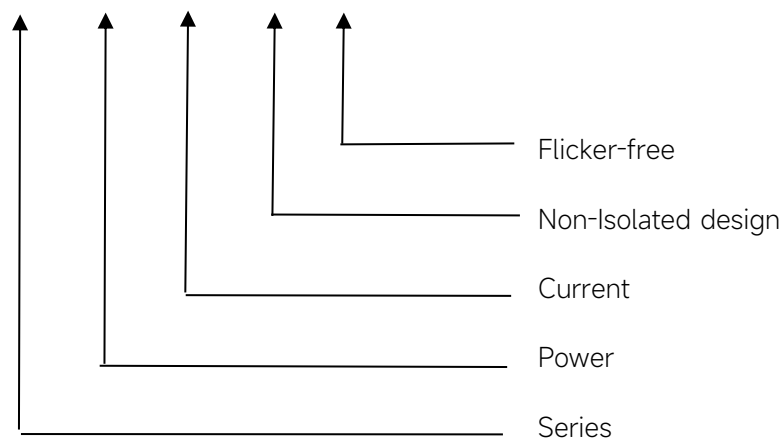

◆ Specification

	Constant Current	200mA	250mA	300mA	350mA
Output	Voltage Range	70-200VDC			70-172VDC
	Unload voltage Max.	250VDC			
	Current Accuracy	±5%			
	Output HF current ripple(≥1KHz)	±15%			
	Output LF current ripple(≤120Hz)	±5%			
	SVM	≤0.4			
	Pst	≤1			
	Efficiency(Typ.)	≥92% @Full load ,220-240V			
	Input	Rated input voltage	220-240VAC		
Range of input voltage		198-264VAC			
Maximum voltage		300VAC@1 h maximum,unit might not operate in this abnormal condition			
Range of input DC voltage(VDC)		176-280VDC			
Frequency(Hz)		0/50/60 Hz			
Displacement factor		≥0.95			
Power Factor		≥0.95 @Full load ,220-240V			
Input Current max		0.38A			
Start-up time		< 0.5S			
No Load Power		≤0.5W			
THD (Typ.)		<10%@Full load ,220-240V			
Protection	Over Load Protection	103-140% YES/Auto Resume			
	Over Voltage Protection	>250V YES/Auto Resume			
	Short circuit Protection	YES/Auto Resume			
	Over Temperature Protection	YES/Auto Resume Ta≥75° C, reducing the output current			
capability	Surge capability (L-N)	2KV			
	Surge capability (L/N-Ground)	2KV			
Environment	Operating Temperature	-20°C~+50°C			
	Humidity	20%-90%RH			
	Tc	85°C			
	Storage Temperature	-25°C~+60°C			
	Life time	> 50000h@Tc=75°C,230VAC			
	Noise	≤25dB(A)@20cm			
Surface	Dimension	190X30X21(LXWXH)mm			
	material	metal case			

Standards	Safety	GB19510. 1, GB19510. 14; IEC61347- 1, IEC61347-2- 13; EN61347- 1, EN61347-2- 13, EN62384;AS/NAS 61347- 1, AS/NAS 61347-2- 13;AS/NZS 61347.1,AS 61347.2.13
	EMC	GB/T17743, GB17625. 1; EN55015, EN61000-3-2, EN61000-3-3, EN61547; EN55015, EN61000-3-2, EN61000-3-3, EN61547; EN61000-4-5
	ErP	Erp2.0 EU 2019/2020
	RoHS	RoHS (2011/65/EU) (EU)2015/863
Note	<p>1.All parameters not specially mentioned are measured at 230VAC input, full load and 25°C of ambient temperature.</p> <p>2.Ripple & Noise are measured at 20MHz of bandwidth by using a 300mm twisted pair-wire terminated with a 0.1uF & 47 uF parallel capacitor.</p> <p>3.Switch and dimmer are not recommended to connect between this product output and luminaries.</p> <p>4.The DC input for this product is only used for emergency lighting and applies to functional and safety requirements, EMC is not considered..</p> <p>5.EL compatible with IEC 61347-2-13 Annex J, compatible with EN 60598-2-22 emergency lighting fixtures, compatible with EN 50172 central battery system applications.</p> <p>6.All Eaglerise power supply are complied with EMI regulations. Since they are belong to component and will be installed inside system enclosure. When they are integrated into a system, the EMI characteristics of the system must be re-verified again.</p>	

Preliminary

◆ Parameter

Number	Output				Switch position	
	Current (mA)	Voltage (VDC)	Voltage No load (VDC)	Power (W)	1	2
1	200mA	70-200	250	40W	--	--
2	250mA			50W	ON	--
3	300mA			60W	--	ON
*4	350mA	70-172		60.2W	ON	ON

* Factory default

◆ Inrush Current

I _{peak}	T _{width}	B10	B16	B20	C10	C16	C20
34.5A	196μs	12pcs	19pcs	24pcs	20pcs	32pcs	40pcs

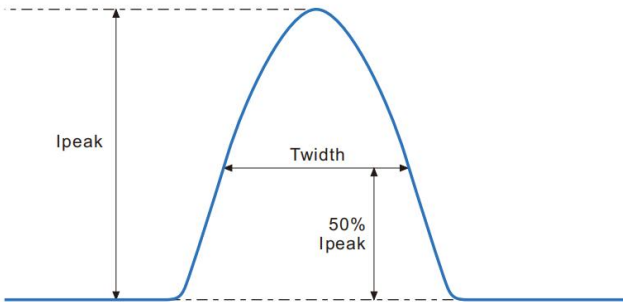

Remarks:

- 1.The number of drives mounted under different MCBs in the table is the maximum value. Please do not exceed this number during installation.
- 2.Different brands and models of miniature circuit breakers, the number of drives mounted will be slightly different.

◆ **Wiring diagram**

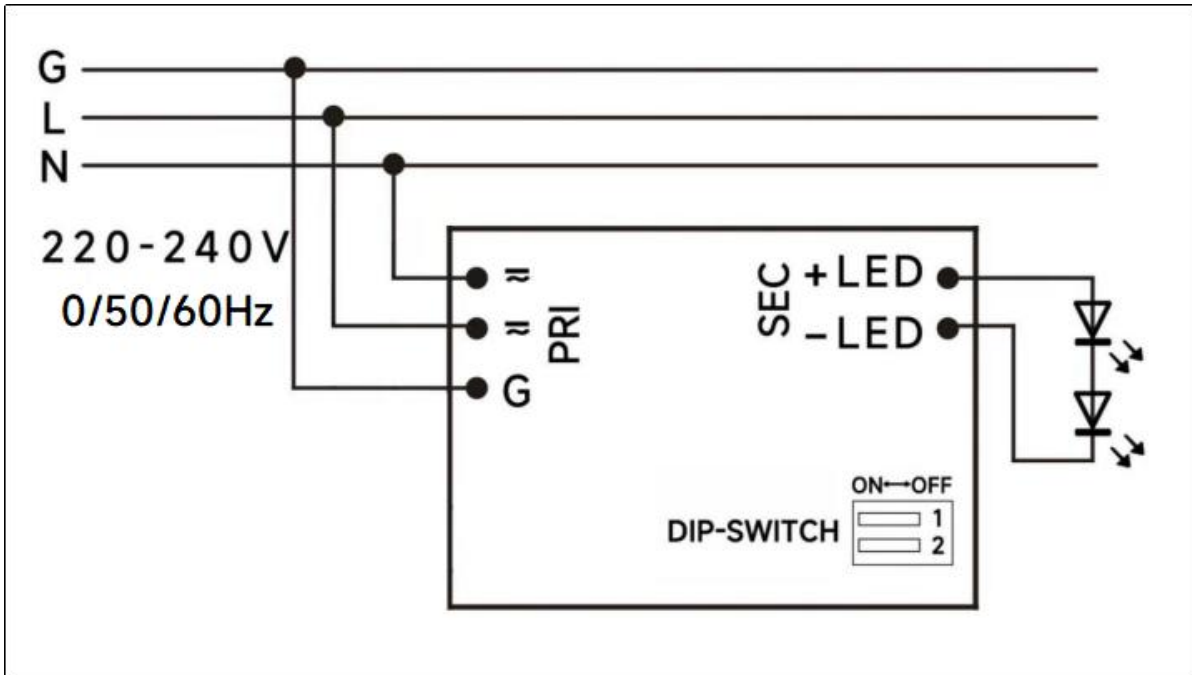

Preliminary

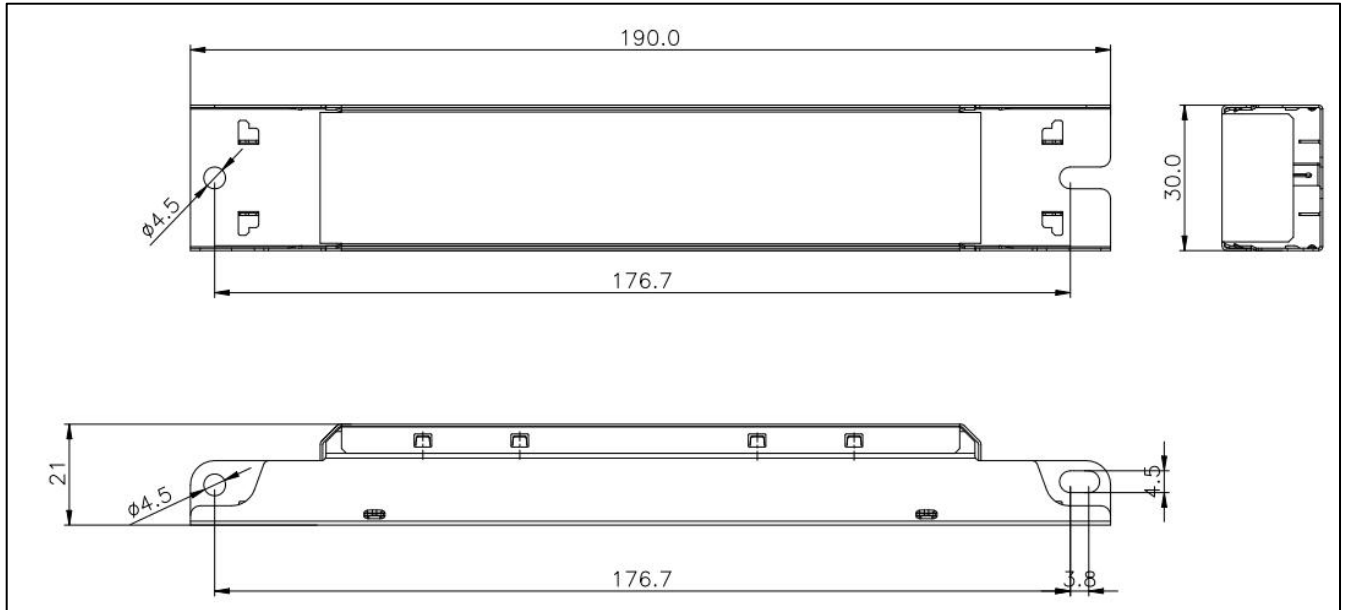
◆ 2D diagram

◆ Wiring & Connections

Specification item		Value (Unit)
Input	Input wire cross-section	0.5...1.5 mm ²
	Input wire gauge.	16...20 AWG
	Input wire strip length	7...9mm
Output	Output wire cross-section	0.5...1.5 mm ²
	Output wire gauge.	16...20 AWG
	Output wire strip length	7...9mm

Note: Solid wire is risky to use on an angled terminal. Stranded wire is recommended for this kind of use.

◆ Curve for FMS-60-350 N-S LD1 E, $I_o=350mA$

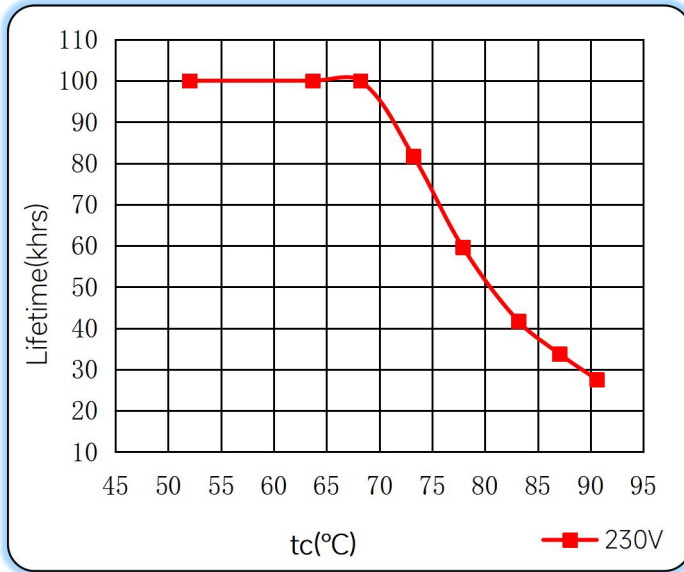
Lifetime vs. Temperature Curve



Efficiency vs. Load

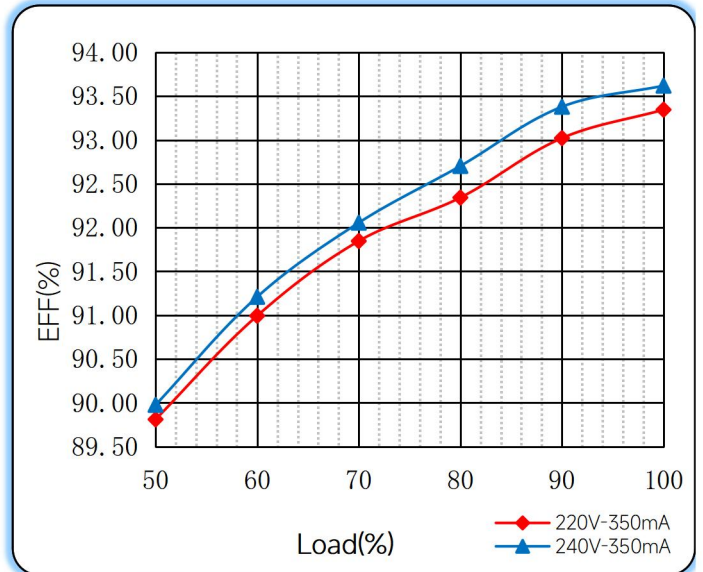

Power Factor Characteristics

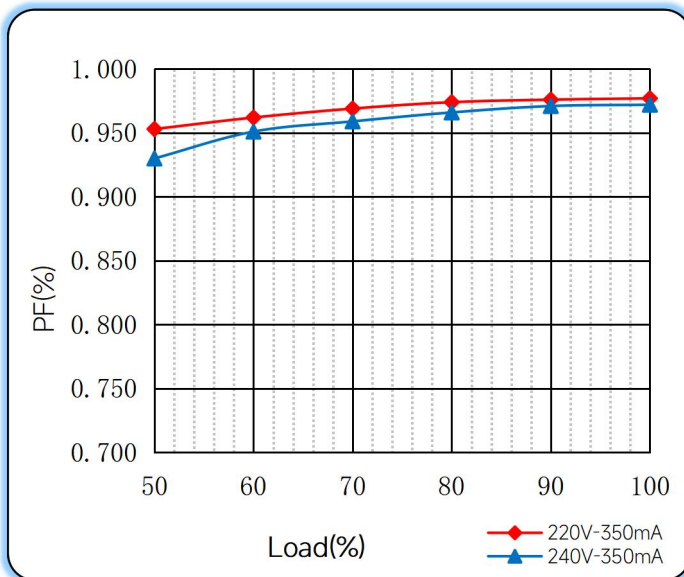

THD vs. Load

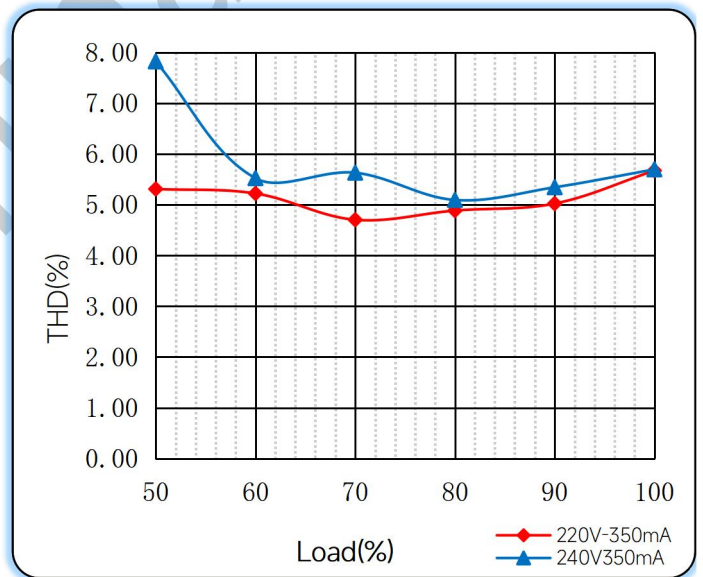

◆ **Operating window**

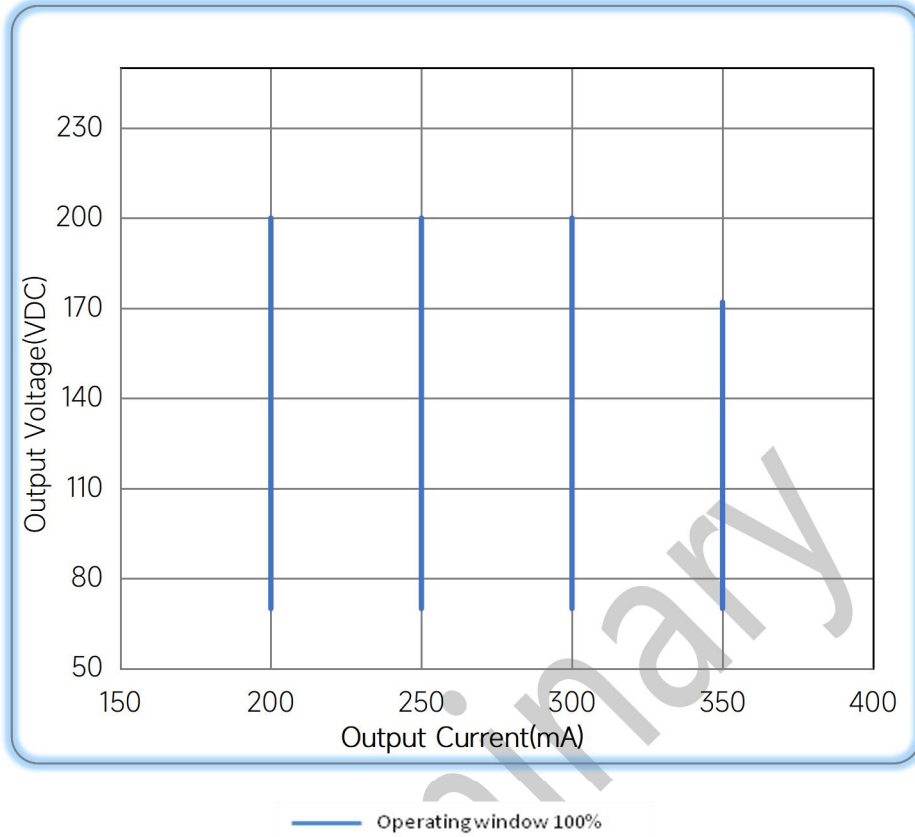

◆ **Revision Updates**

ITEM	BEFORE	AFTER	VERSION	DATE
Initial			A	2024/01/09
Life time	50000h@Tc=80°C,230VAC	50000h@Tc=75°C,230VAC	B	2024/02/22

Remark: The final interpretation of the contents of the specification belongs to Eaglerise Electric & Electronic (China) Co., Ltd.

Tel: +86-0757-86256822, +86-0757-86256831

E-mail: sales@eaglerise.com

Website : <https://lighting.eaglerise.com>



EAGLERISE



Manual