

21W Constant Current -FDS power supply

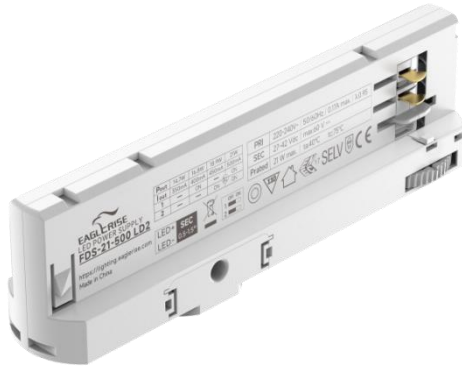

■ Approve



Features

- Class II, SELV, built-in
- Input Voltage 220-240VAC
- Protections: SCP/OLP/OVP
- Power Factor: >0.95
- Efficiency: ≥84%
- Adjustable Output Current with dip-switch
- 5 years warranty
- IP20

Applications

- Track Spot light

◆ Description

FDS-21-500 LD2 is a 21W constant current LED driver that operates from 176-264Vac input with 350 to 500mA output current and a forward voltage range from 20 to 42Vdc. The output current is adjustable by DIP Switch. With it's compact dimensions from 161.8 x 30.6 x 44.5 mm it is easy to integrate in track spot light products. To ensure trouble-free operation, protection is provided against output short circuit and over Load.

◆ Model code

FDS-21-500 LD2

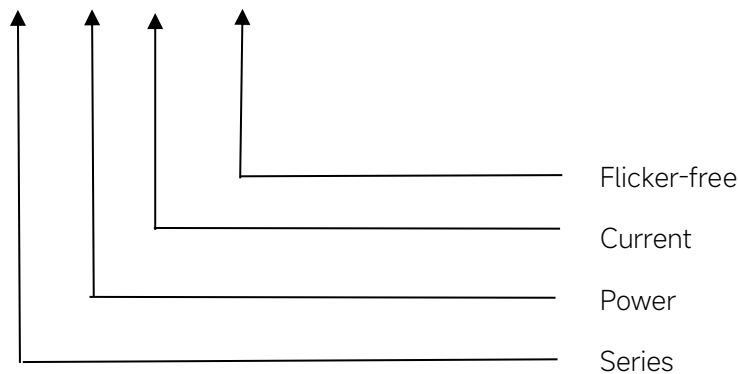

◆ Specification

Output	Constant Current	350mA	400mA	...	500mA
	Voltage Range	20-42VDC	20-42VDC	...	20-42VDC
	Unload voltage Max.	60VDC	60VDC	...	60VDC
	Current Accuracy	±7%			
	Output HF current ripple(≥1KHz)	±5%			
	Output LF current ripple(≤120Hz)	±5%			
	SVM	≤0.4			
	P _{st}	≤1			
	Efficiency(Typ.)	≥84%@Full load			
Input	Rated input voltage	220-240VAC			
	Range of input voltage	176-264VAC			
	Range input voltage(DC)	176-280VDC			
	Frequency(Hz)	0/50/60 Hz			
	Displacement factor	≥0.9			
	Power Factor	>0.95@Full load			
	Input Current max	0.17A MAX.			
	Start-up time	< 0.5 S			
	No Load Power	≤0.5W			
	THD (Typ.)	<10%@Full load			
Protection	Over Load Protection	103-120% YES/Auto Resume			
	Over Voltage Protection	> 60VDC YES/Auto Resume			
	Short circuit Protection	YES/Auto Resume			
Environment	Operating Temperature	-20°C~+35°C			
	Humidity	10%-90%RH			
	T _c	75°C			
	Storage Temperature	-20°C~+60°C			
	Life time	> 50000h@T _c =75°C			
Surface	Dimension	161.8X30.6X44.5(LXWXH)mm			
Standards	EN 61347-1,EN 61347-2-13(CE-LVD,ENEC); IEC 61347-1,IEC 61347-2-13(CB); EN 62384(ENEC) EN IEC 55015,EN IEC 61000-3-2,EN 61000-3-3(CE-EMC,RCM)EN 61547(CE-EMC,RCM)				
Others	ErP	EU 2019/2020			
	RoHS	RoHS (2011/65/EU) (EU)2015/863			
Note	1.All parameters NOT specially mentioned are measured at 230VAC input , full load and 25°C of ambient temperature. 2.Ripple & Noise are measured at 20MHz of bandwidth by using a 300mm twisted pair-wire terminated with a 0.1uF & 47 uF parallel capacitor.				

◆ Parameter

Number	Output				Switch position	
	Current (mA)	Voltage (VDC)	Voltage No load (VDC)	Power (W)	1	2
1	350mA	20-42	60	14.7	--	--
2	400mA			16.8	ON	--
3	450mA			18.9	--	ON
4	500mA			21	ON	ON

* Factory default

◆ Inrush Current

I ^{peak}	T _{width}	B10	B16	B20	C10	C16	C20
11.6A	104.2μs	47pcs	75pcs	94pcs	47pcs	75pcs	94pcs

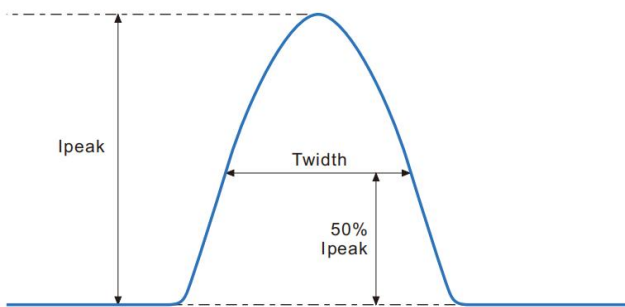

Remarks:

- 1.The number of drives mounted under different MCBs in the table is the maximum value. Please do not exceed this number during installation.
- 2.Different brands and models of miniature circuit breakers, the number of drives mounted will be slightly different.

◆ Wiring diagram

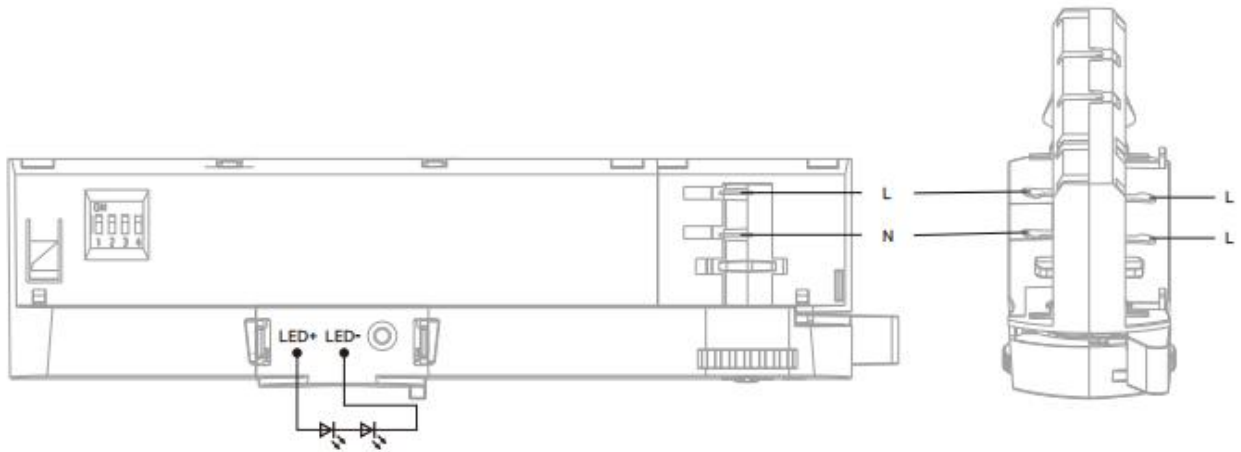

◆ 2D diagram

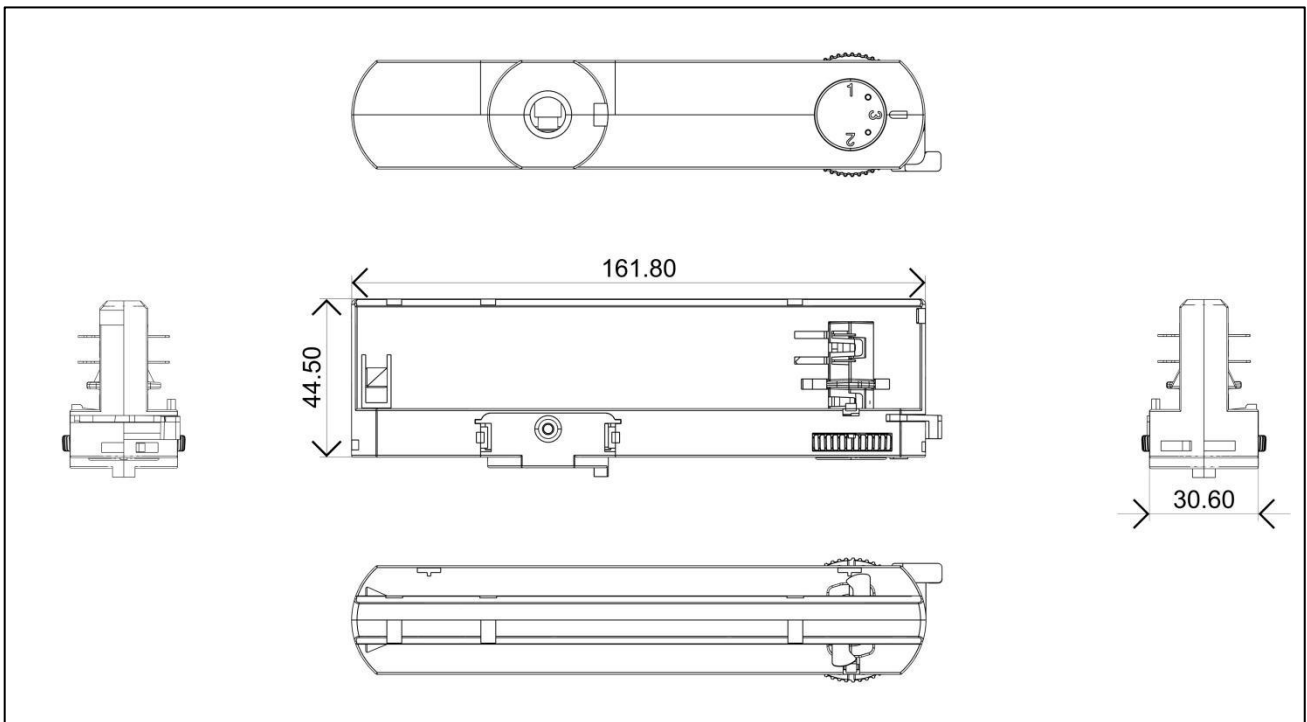

◆ Matching brand

Brand	IVELA	7501
	STUCCHI	9000XX Series
	POWERGEAR	PRO-0431
	GLOBAL	XTS 4 & XTSF 4
	Unipro	T32B
	JBD	H-04
	GUANG FA	GF016
	JIN HAOTAI	4 wires

◆ Matching description

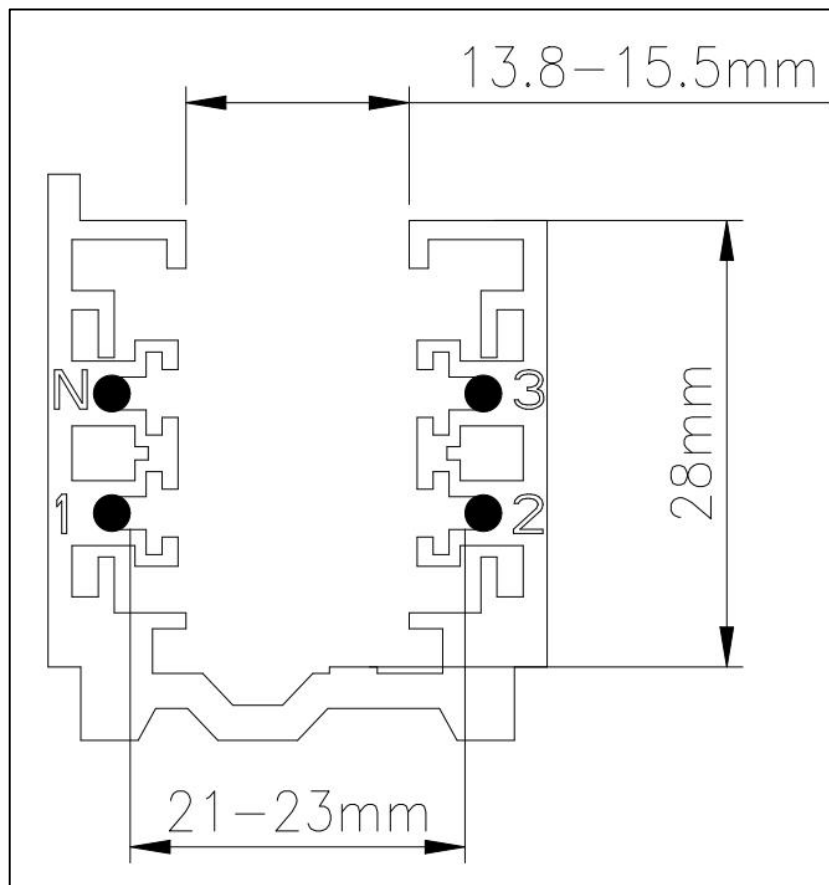

◆ **Curve for FDS-21-500 LD2, I_o=500mA**

Lifetime vs. Temperature Curve

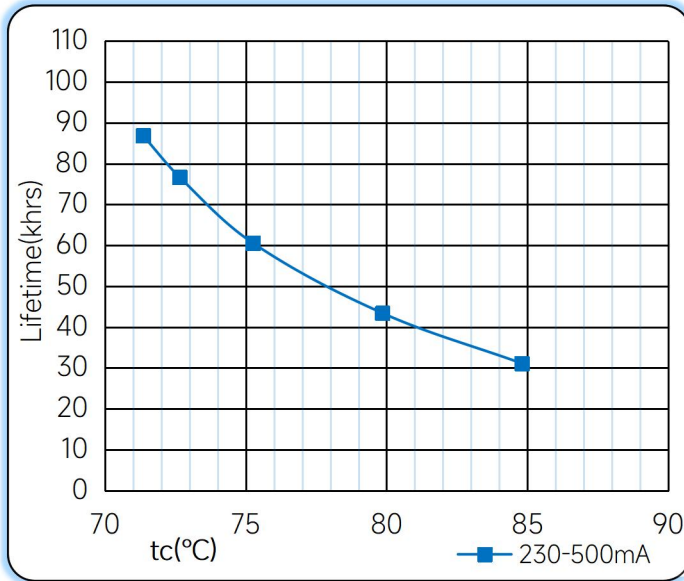

Efficiency vs. Load

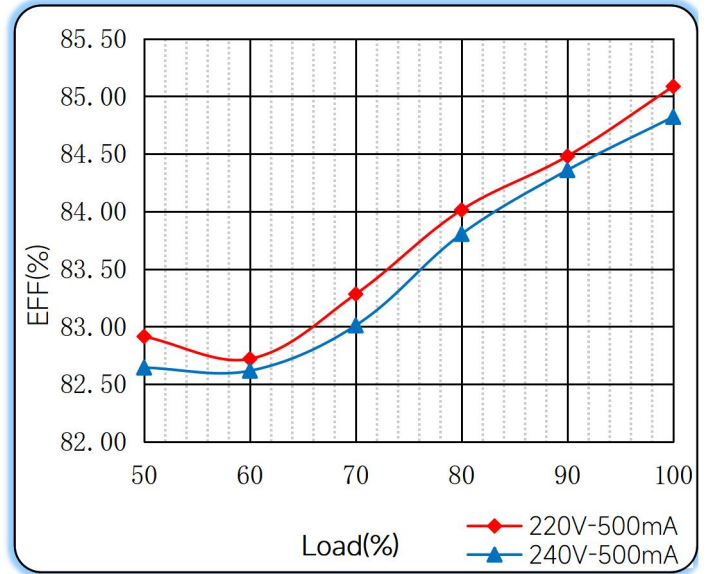

Power Factor Characteristics

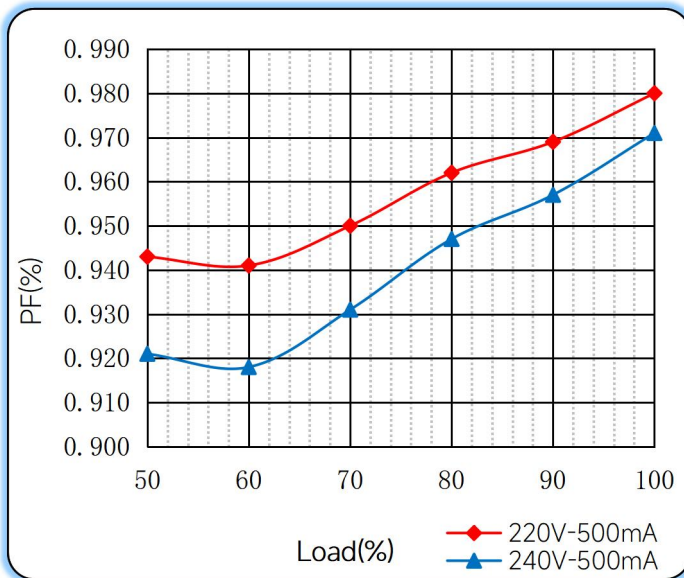

THD vs. Load

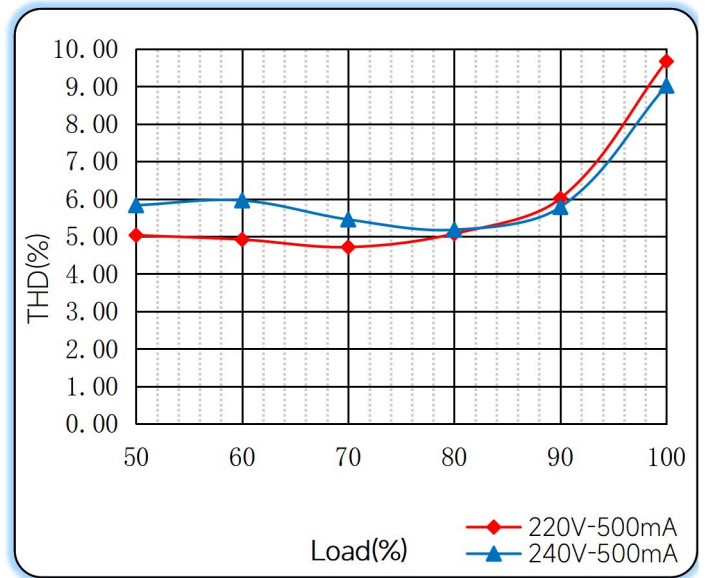

◆ Operating window

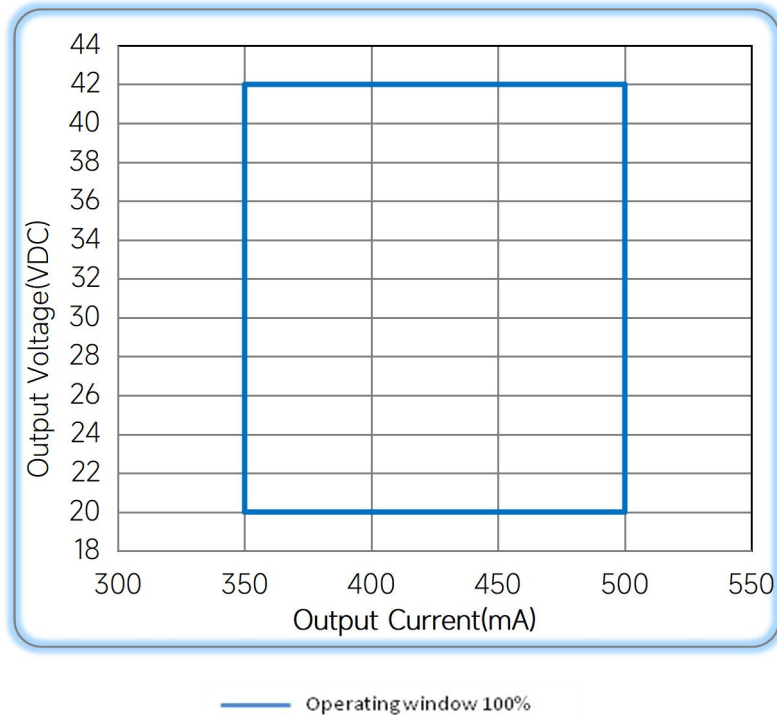

◆ Revision Updates

ITEM	BEFORE	AFTER	VERSION	DATE
Initial			A	2022/10/24
Brand			B	2023/7/22

Tel: +86-0757-86256822, +86-0757-86256831

E-mail: sales@eaglerise.com

Website : <https://lighting.eaglerise.com>



EAGLERISE



Manual