

55W Constant Current – DIP-Switch



■ Approve



Features

- Class I, SELV, built-in
- Input Voltage 220-240VAC
- Protections: SCP/OLP/OVP
- Power Factor > 0.95
- Efficiency ≥90%
- 5 years warranty

Applications

- Linear light

◆ Description

FMS-55-1050 LD is a 55W constant current LED driver that operates from 198-264Vac input with 800 to 1050mA output current. The output current is selectable by DIP Switch. With its dimensions from 280 x 30 x 21mm it is easy to integrate in linear light products. To ensure trouble-free operation, protection is provided against output short circuit and over Load.

◆ Model code

FMS-55-1050 LD

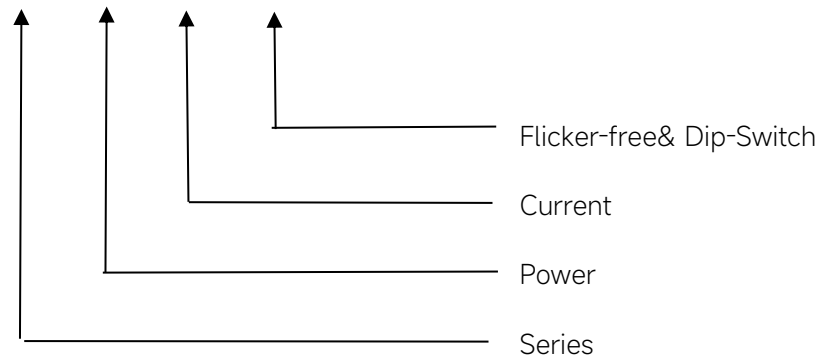

◆ Specification

	Constant Current	800mA	900mA	950mA	1000mA	1050mA
Output	Voltage Range	36-52VDC				
	Unload voltage Max.	63VDC				
	Current Accuracy	±5%				
	Output HF current ripple(≥1KHz)	±3%				
	Output LF current ripple(≤120Hz)	±3%				
	SVM	≤0.4				
	Pst	≤1				
	Efficiency(Typ.)	≥90%				
	Input	Rated input voltage	220-240VAC			
Range of input voltage		198-264VAC				
Frequency(Hz)		50/60 Hz				
Power Factor		> 0.95C				
Input Current max		0.4A				
Start-up time		< 0.5S				
No Load Power		≤0.5W				
THD (Typ.)		< 18%.				
Protection	Over Load Protection	103-120% YES/Auto Resume				
	Over Voltage Protection	> 63VDC YES/Auto Resume				
	Short circuit Protection	YES/Auto Resume				
Environment	Operating Temperature	-20°C~+50°C				
	Humidity	20%-90%RH				
	Tc	75°C				
	Storage Temperature	-25°C~+60°C				
	Life time	> 50000h@Tc=65°C,230VAC				
Surface	Dimension	280X30X21(LXWXH)mm				
standards	EN 61347-1; EN61347-2-13; EN62384; EN55015; EN61000-3-2 ; EN61000-3-3; EN 61547;					
Others	ErP	EU 2019/2020				
	RoHS	RoHS (2011/65/EU) (EU)2015/863				
Note	1.All parameters NOT specially mentioned are measured at 230VAC input , full load and 25°C of ambient temperature. 2.Ripple & Noise are measured at 20MHz of bandwidth by using a 300mm twisted pair-wire terminated with a 0.1uF & 47 uF parallel capacitor.					

◆ Parameter

Number	Output				Switch position		
	Current (mA) I1+I2	Voltage (VDC)	Voltage No load (VDC)	Power (W)	1	2	3
1	800mA	36-52	63	41.6W	--	--	--
2	900mA			46.8W	--	--	ON
3	950mA			49.4W	--	ON	--
4	1000mA			52W	ON	--	ON
*5	*1050mA			54.6W	ON	ON	--

* Factory default

◆ Wiring diagram

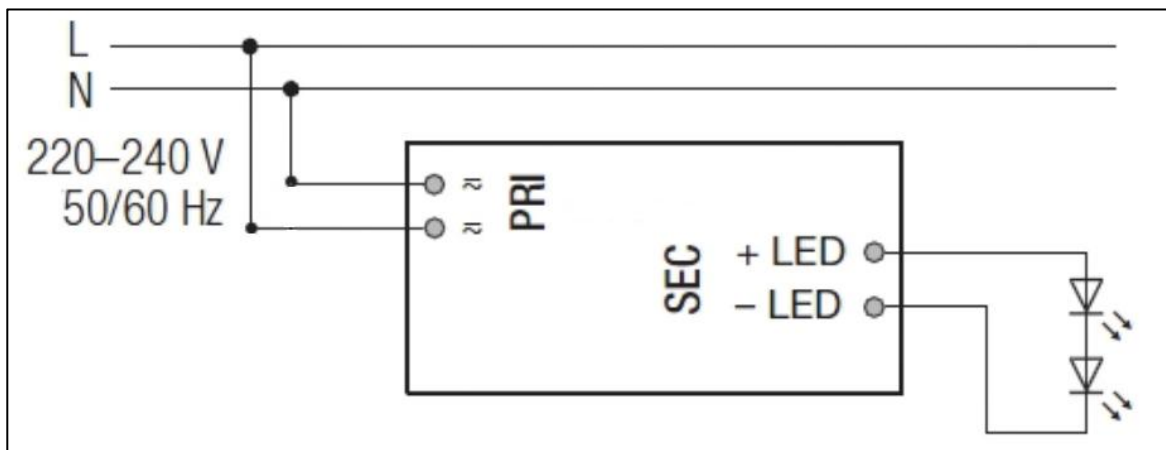

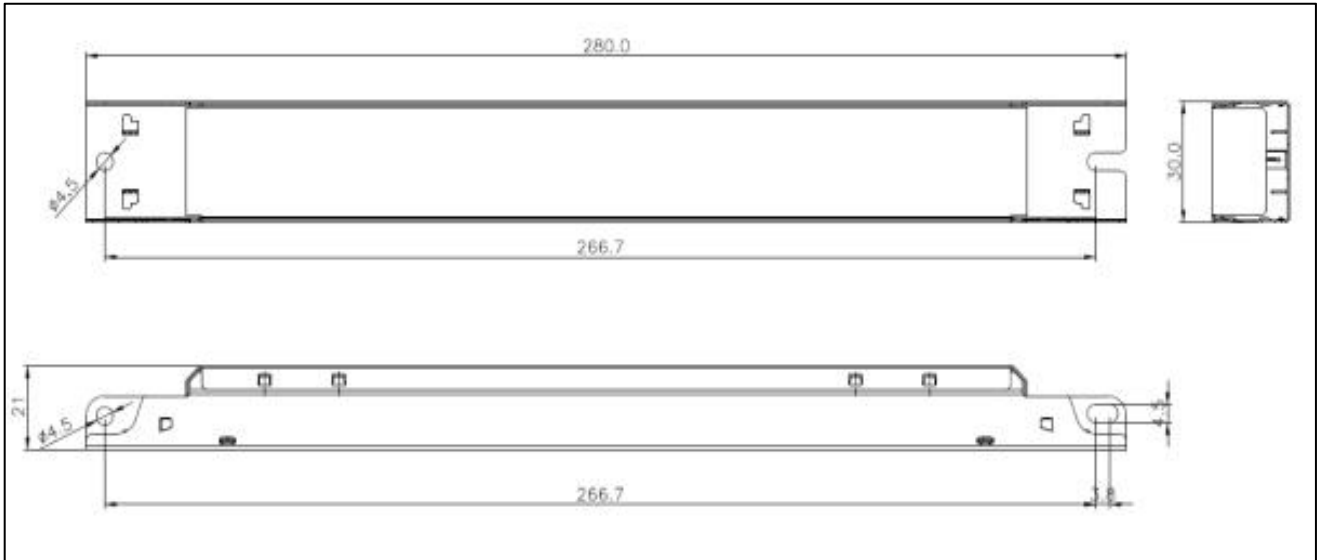
◆ 2D diagram

◆ Wiring & Connections

	Specification item	Value (Unit)
Input	Input wire cross-section	0.5...1.5 mm ²
	Input wire gauge.	16...20 AWG
	Input wire strip length	7...9mm
Output	Output wire cross-section	0.5...1.5 mm ²
	Output wire gauge.	16...20 AWG
	Output wire strip length	7...9mm

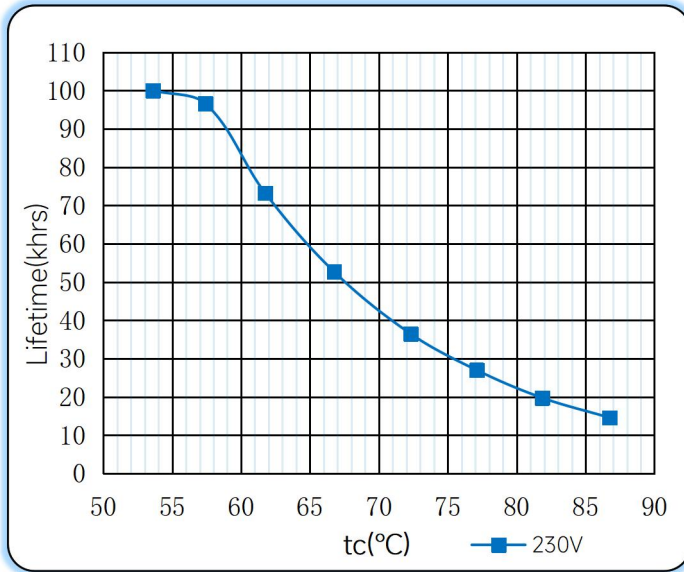
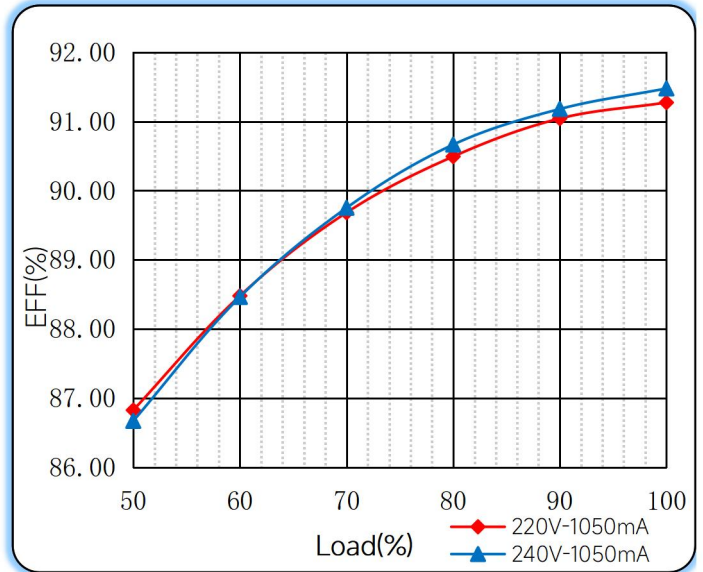
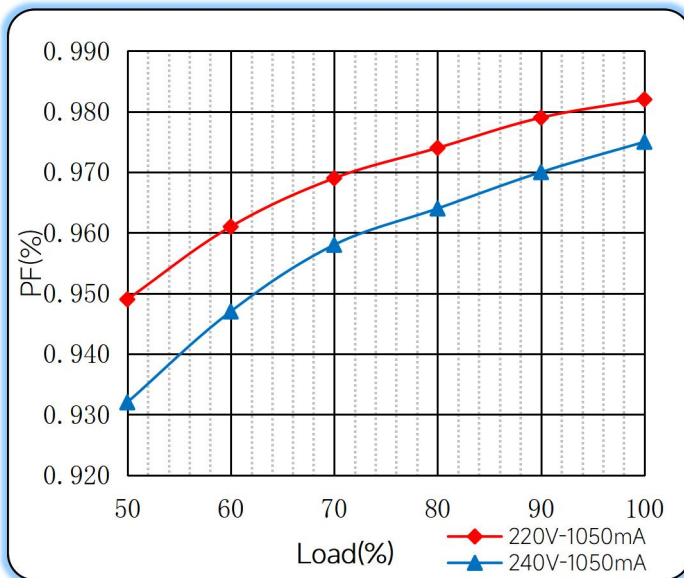
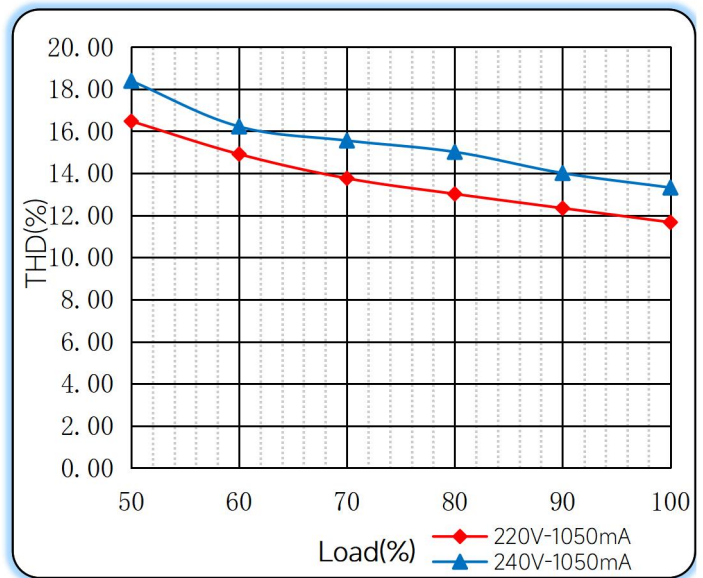
◆ Curve for FMS-55-1050 LD, $I_o=1050mA$

Lifetime vs. Temperature Curve

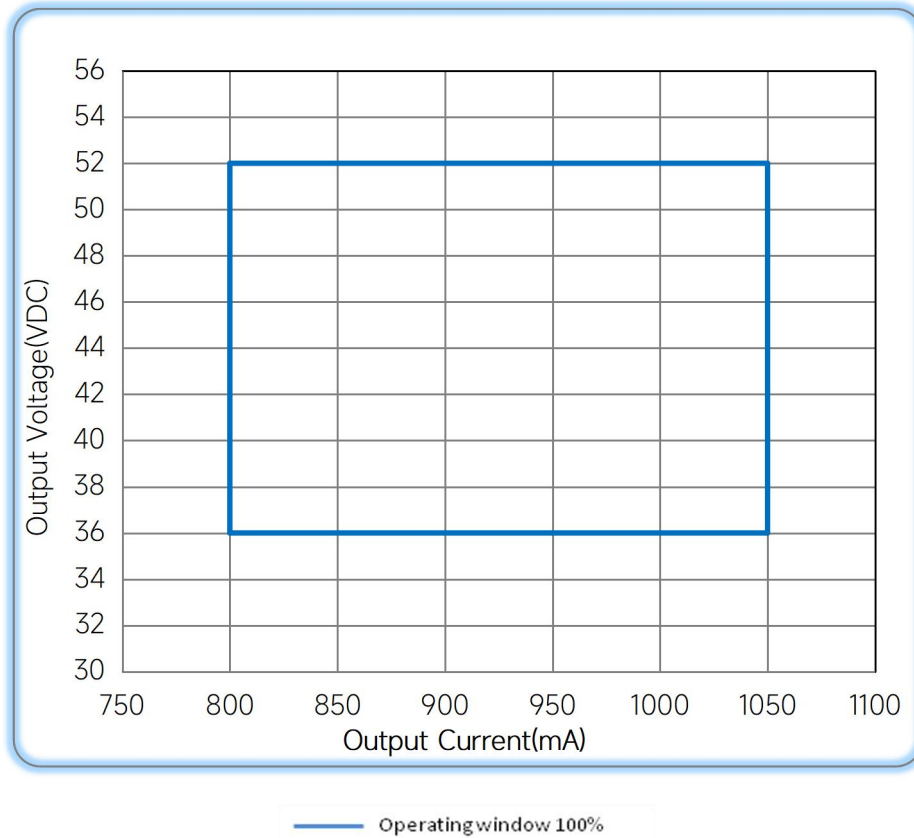
Efficiency vs. Load

Power Factor Characteristics

THD vs. Load

◆ Operating window



◆ Revision Updates

ITEM	BEFORE	AFTER	VERSION	DATE
Initial			A	2022/05/15

Tel: +86-0757-86256822, +86-0757-86256831

E-mail: sales@eaglerise.com

Website : <https://lighting.eaglerise.com>



EAGLERISE



Manual