

## 40W Constant Current-LS Series

LS-40-XXX LI4

### ■ Approve



### ■ Features

- Class II, SELV, independent
- Input Voltage 220-240VAC
- Protections: SCP/OLP/OVP
- Power Factor >0.95
- Efficiency ≥87%
- 5 years warranty

### ■ Applications

- LED panel
- LED spot light
- LED down light

### ■ Description

LS-40-XXX LI4 is a 40W constant current LED driver with 600 to 1050mA output current. With its compact dimensions from 116 x 41 x 25mm it is easy to integrate in LED Panel, spot and down lights product. To ensure trouble-free operation, protection is provided against output short circuit and over Load.

### ■ Model code

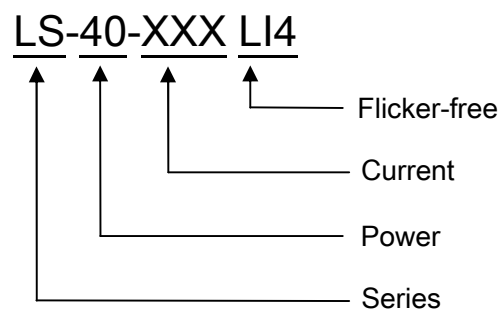

## 40W Constant Current-LS Series

LS-40-XXX LI4

### ■ Specification

Input	Rated input voltage	220-240VAC				
	Range of input voltage	176-264VAC				
	Range of input voltage(DC)	176-280V				
	Frequency(Hz)	50/60 Hz				
	Power Factor	> 0.95@230VAC, full Load				
	Input Current max	0.29A MAX. @Full Load,176VAC (Please see Model list below for details)				
	Start-up time	< 0.5S				
	Unload Power Consumption	≤0.5W				
	Inrush Current	40A Max./175μs@230V, Full Load , 50%Ipk-50%Ipk				
	THD	< 10% @230VAC, full Load				
	Leakage Current	< 0.7mA(240VAC)				
Output	Constant Current Max. *Note.3	600mA	650mA	700mA	...	1050mA
	Unload voltage Max.	50VDC	50VDC	50VDC	...	52VDC
	Voltage Range(VDC)	24-42VDC	24-42VDC	24-42VDC	...	24-38.5VDC
	Rated power	25.2W Max.	27.3W Max.	29.4 W Max.	...	40.4W Max.
	Current Accuracy	±5%@220-240VAC				
	Voltage Regulation	±5% @Full Load, 220-240VAC				
	Load Regulation	±5%@220-240VAC				
	Hold-up Time	1s max.@Full Load				
	Ripple& Noise *Note.2	≤±5% @Full Load , 230VAC				
	Efficiency(Typ.)	≥87% @Full Load , 230VAC				
Protection	Over Load Protection	103-120%				
		Protection type: Auto Resume				
	Over Voltage Protection	> 50VDC	> 50VDC	> 50VDC	...	> 52VDC
	Protection type: Auto Resume					
	Short circuit Protection	Protection type: Auto Resume				
Environment	Operating Temperature	-20°C...+45°C				
	tc	85°C				
	Storage Temperature	-25°C...+60°C				
	Life time	> 50,000h@ta=45°C, 230VAC				
	Humidity	20%-90%RH				
Others	Dimension	116X41X25(LXWXH)mm				
Safety & EMC	Safety standards	EN 61347-1; EN61347-2-13; EN62384				
	Withstand voltage	Input-Output : 3750V/5mA/1min				
	Isolation resistance	Input-Output : ≥4MΩ@500VDC				
	EMI	EN55015; EN61000-3-2 Class C; EN61000-3-3				
	EMS	EN 61547; EN 61000-4-2; EN 61000-4-5 —1000V;				
Note	1.All parameters NOT specially mentioned are measured at 240VAC input , full load and 25°C of ambient temperature. 2.Ripple & Noise are measured at 20MHz of bandwidth by using a 300mm twisted pair-wire terminated with a 0.1uF & 47 uF parallel capacitor. 3.Output current can be from 600mA to 1050mA and increasing in multiples of 50mA. Please see Model list below and contact EAGLERISE for details.					

## 40W Constant Current-LS Series

LS-40-XXX LI4

### Model list

No.	Model number	Input			Output			
		Voltage (VAC)	Current (A)	Frequency (Hz)	Constant current (mA)	Normal working voltage (VDC)	No load working voltage (VDC)	P <sub>rated</sub> (W)
1	LS-40-600 LI4	220-240	0.17	50/60	600	24-42	50	25.2
2	LS-40-650 LI4	220-240	0.19	50/60	650	24-42	50	27.3
3	LS-40-700 LI4	220-240	0.20	50/60	700	24-42	50	29.4
4	LS-40-750 LI4	220-240	0.22	50/60	750	24-42	50	31.5
5	LS-40-800 LI4	220-240	0.23	50/60	800	24-42	50	33.6
6	LS-40-850 LI4	220-240	0.25	50/60	850	24-42	50	35.7
7	LS-40-900 LI4	220-240	0.26	50/60	900	24-42	50	37.8
8	LS-40-950 LI4	220-240	0.27	50/60	950	24-42	50	39.9
9	LS-40-1000 LI4	220-240	0.27	50/60	1000	24-40	50	40
10	LS-40-1050 LI4	220-240	0.29	50/60	1050	24-38.5	52	40.4

### Connection diagram

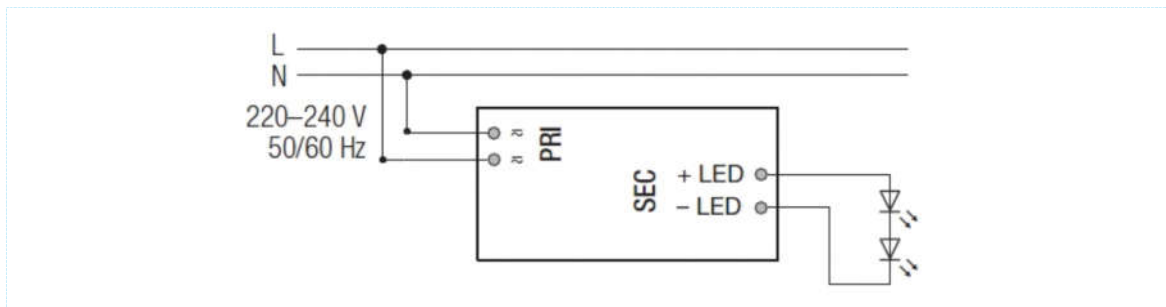

### 2D diagram

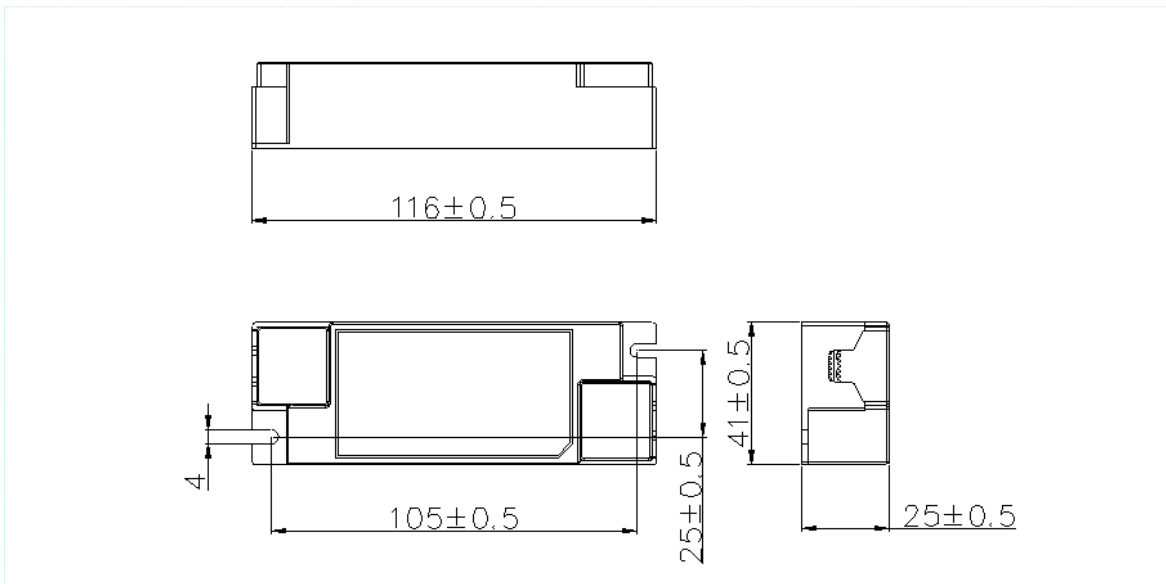

## 40W Constant Current-LS Series

### LS-40-XXX LI4

#### ■ Curve for LS-40-900 LI4

##### Lifetime vs. Ambient Temperature Curve

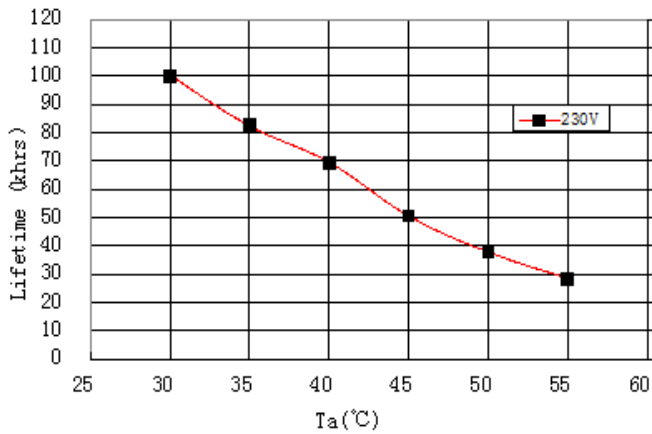

##### Efficiency vs. Load

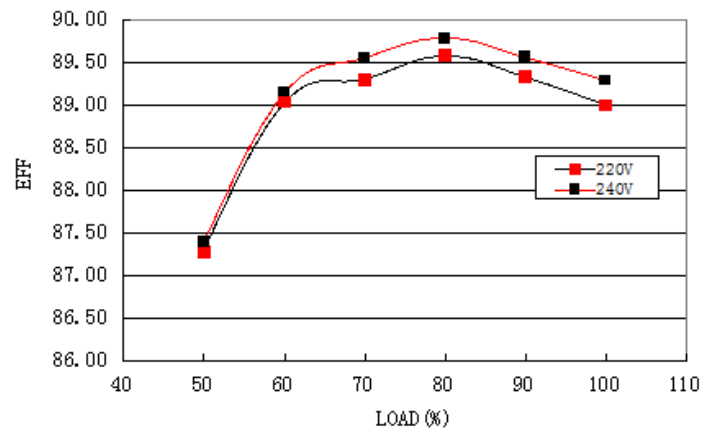

##### Power Factor Characteristics

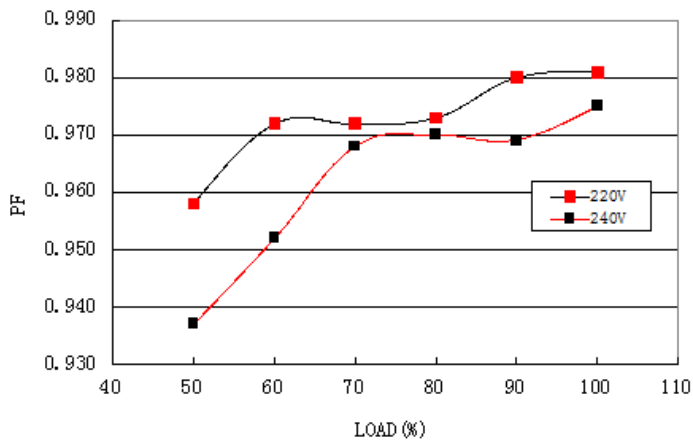

##### THD vs. Load

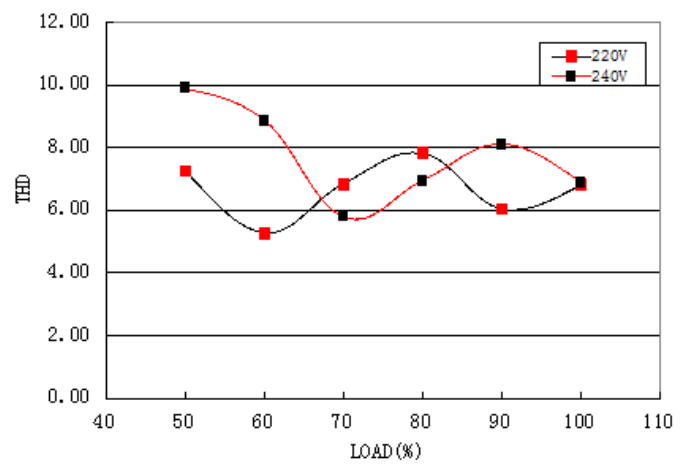

## 40W Constant Current-LS Series

LS-40-XXX LI4

### ■ Operating window

