

## 100W Constant Current-FMS Series



■ Approve



### Features

- Class I, Non-isolated, Built-in
- Input Voltage 220-240VAC
- Protections: SCP/OVP/OTP
- Power Factor: 0.95(Typ.)
- Efficiency: 90%(Typ.)
- Adjustable Output Current with dip-switch
- 5 years warranty
- IP20

### Applications

- Linear light

### ◆ Description

FMS-100-700 N-S LD EXC is a 100W constant current LED driver that operates from 198-264Vac input with 350 to 700mA output current. The output current is adjustable by DIP Switch. With it's dimensions from 280x30x21mm. It is easy to integrate in linear light products. To ensure trouble-free operation, protection is provided against output short circuit, over voltage and over temperature.

### ◆ Model code

#### FMS-100-700 N-S LD EXC

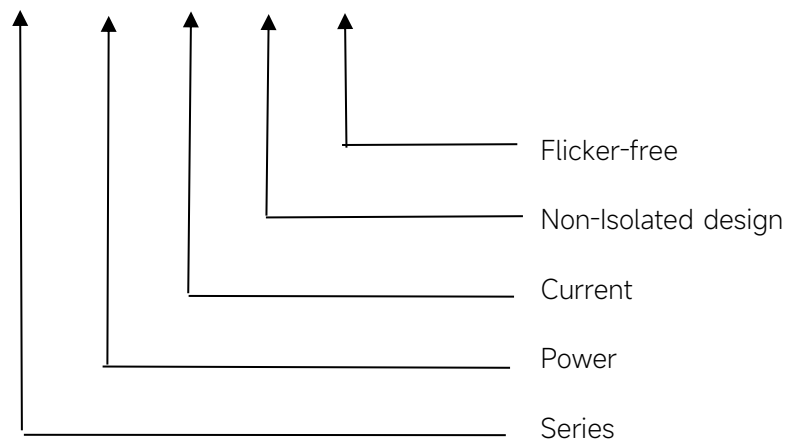

## ◆ Specification

	Constant Current	350mA	400mA	...mA	700mA	
Output	Voltage Range	40-220VDC				
	Unload voltage Max.(VDC)	250VDC				
	Current Accuracy	±5%				
	Output HF current ripple(≥1KHz)	±5%				
	Output LF current ripple(<120Hz)	±5%				
	SVM	≤0.4				
	Pst	≤1				
	Efficiency(Typ.)	≥90%@Full load ,220-240V				
	Input	Rated input voltage	220-240VAC			
Range of input voltage		198-264VAC				
Range of input DC voltage(VDC)		198-280VDC				
Frequency(Hz)		0/50/60 Hz				
Displacement factor		≥0.9				
Power Factor		≥0.95@Full load ,220-240V				
Input Current max		0.6A				
Start-up time		< 0.5S				
No Load Power		≤0.5W				
THD (Typ.)		<10% @Full load ,220-240V				
Protection	Over Voltage Protection	YES/Auto Resume				
	Short circuit Protection	YES/Auto Resume				
	Over Temperature Protection	YES/Auto Resume Ta≥75° C, reducing the output current				
Environment	Operating Temperature	25°C~+60°C				
	Humidity	20%-90%RH				
	Maximum case temperature(Tc)	85°C				
	Storage Temperature	-40°C~+85°C				
	Life time	>50,000h@Tc=85°C >100,000h@Tc=75°C				
	Ripple & Noise	≤20dB(A)@20cm				
Surface	Dimension	280X30X21(LXWXH)mm				
Standards	IEC61347- 1, IEC61347-2- 13; EN61347- 1, EN61347-2- 13; EN61347- 1, EN61347-2- 13, EN62384; GB/T17743, GB17625. 1, GB19510. 1, GB19510. 14; EN55015, EN61000-3-2, EN61000-3-3, EN61547					
Others	ErP	EU 2019/2020				
	RoHS	RoHS (2011/65/EU) (EU)2015/863				
Note	1.All parameters not specially mentioned are measured at 230VAC input, full load and 25°C of ambient temperature. 2.Ripple & Noise are measured at 20MHz of bandwidth by using a 300mm twisted pair-wire terminated with a 0.1uF & 47 uF parallel capacitor. 3.Switch and dimmer are not recommended to connect between this product output and luminaries.					

## ◆ Parameter

Number	Output				Switch position		
	Current (mA)	Voltage (VDC)	Voltage No load (VDC)	Power (W)	1	2	3
1	350mA	40-220	250	77W	--	--	--
2	400mA	40-220		88W	ON	--	--
3	450mA	40-220		99W	--	ON	--
4	500mA	40-200		100W	ON	ON	--
5	550mA	40-180		99W	--	--	ON
6	600mA	40-160		96W	ON	--	ON
7	650mA	40-146		94.9W	--	ON	ON
*8	700mA	40-136		95.2W	ON	ON	ON

\* Factory default

## ◆ Circuit Breaker

I <sub>peak</sub>	T <sub>width</sub>	B10	B16	B20	C10	C16	C20
41.8A	258μs	7pcs	11pcs	14pcs	12pcs	19pcs	24pcs

## ◆ Wiring diagram

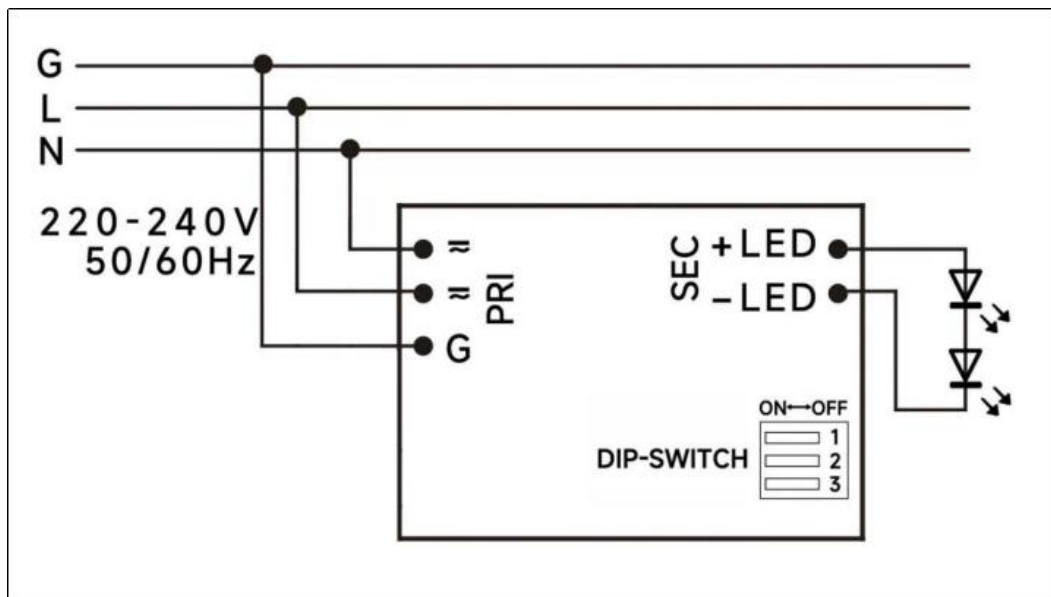

◆ 2D diagram

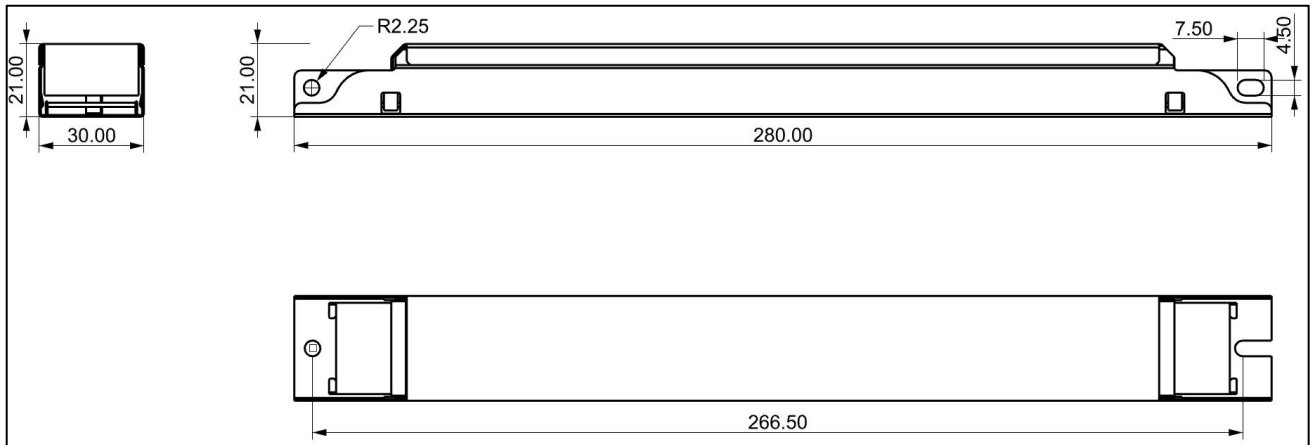

## ◆ Curve for FMS-100-700 N-S LD EXC, I<sub>o</sub>=700mA

### Lifetime vs. Temperature Curve

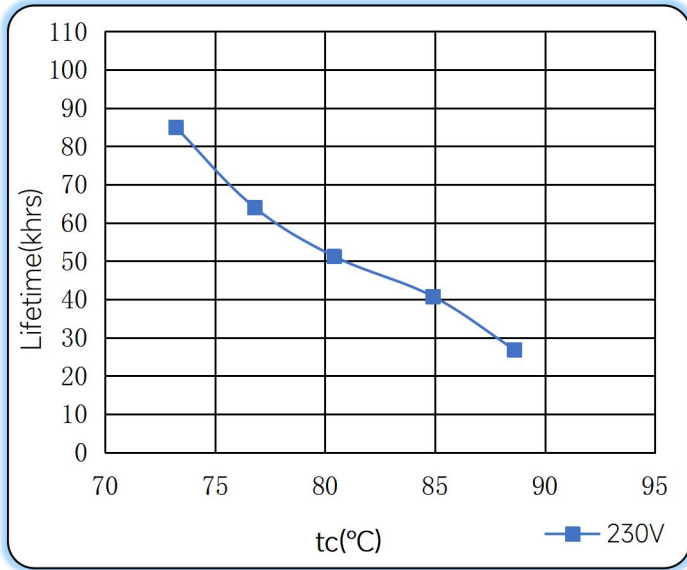

### Efficiency vs. Load

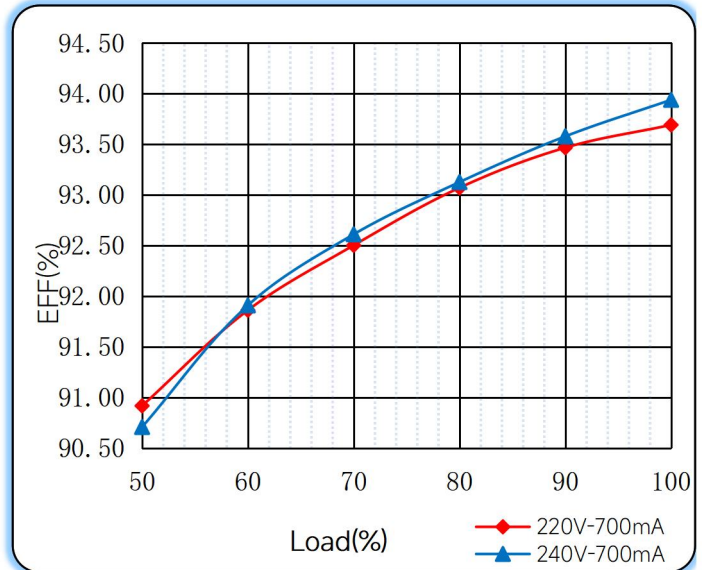

### Power Factor Characteristics

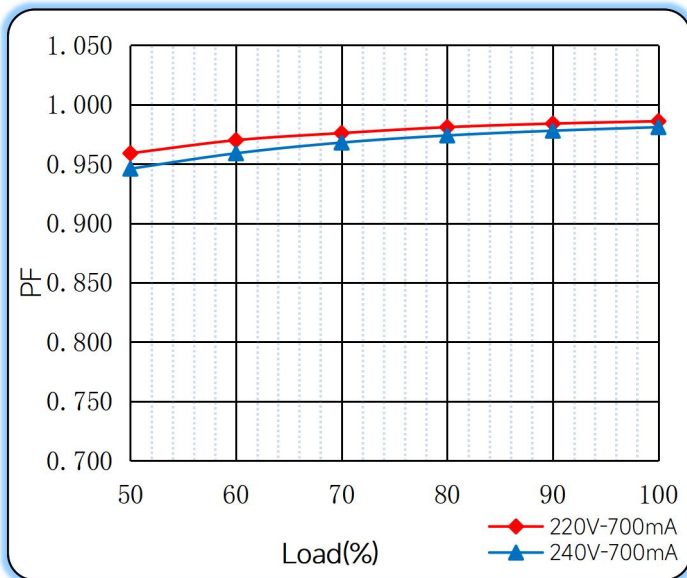

### THD vs. Load

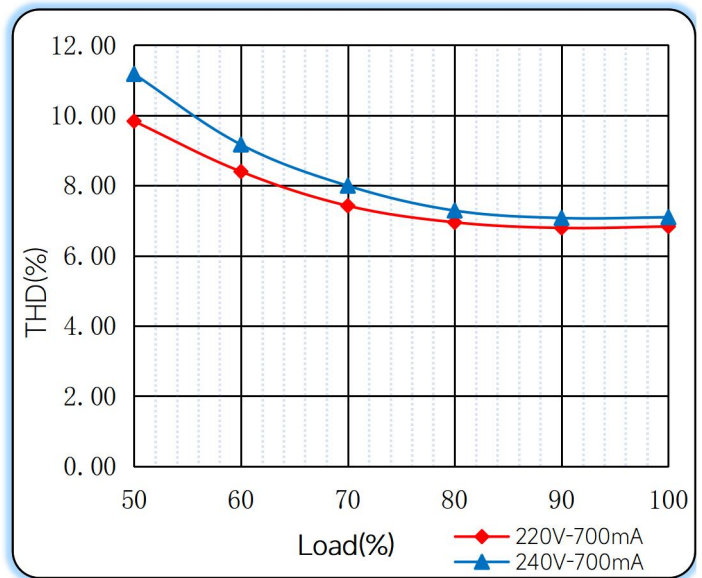

◆ **Operating window**

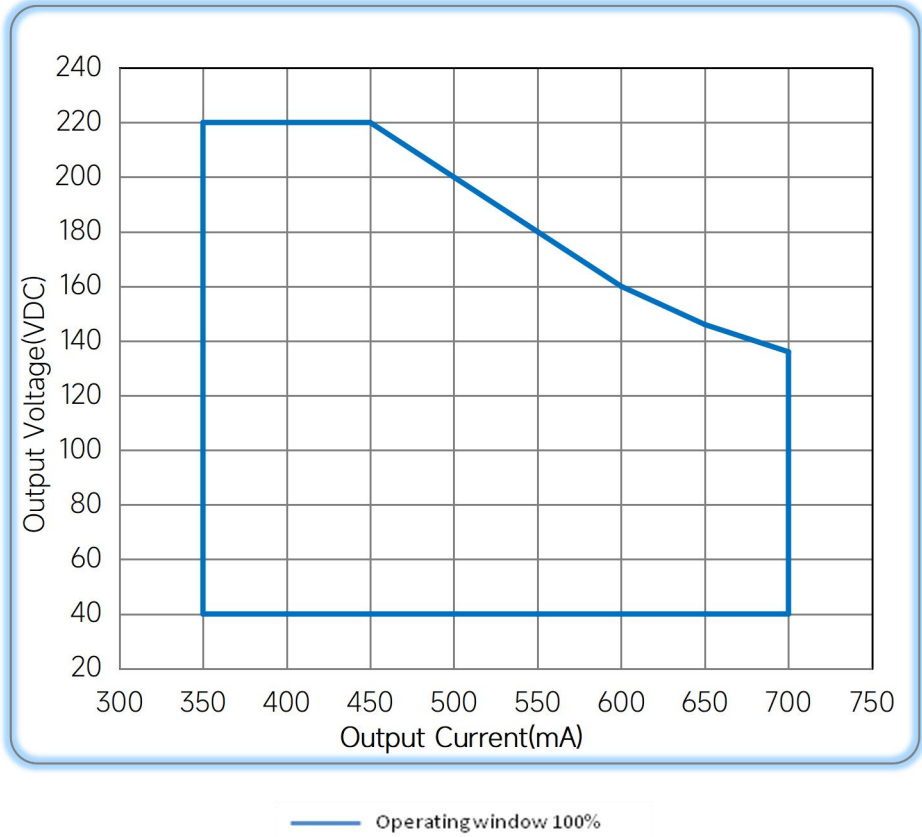

◆ **Revision Updates**

ITEM	BEFORE	AFTER	VERSION	DATE
Initial			A	2023/01/13
		Updated	B	2023/05/30
Range of input DC voltage(VDC)	176-280VDC	198-280VDC	C	2024/04/30

Tel: +86-0757-86256822, +86-0757-86256831

E-mail: sales@eaglerise.com

Website : <https://lighting.eaglerise.com>



EAGLERISE



Manual